

Use of CRP Fields by Greater Sage-grouse and other Shrubsteppe associated Wildlife in Washington

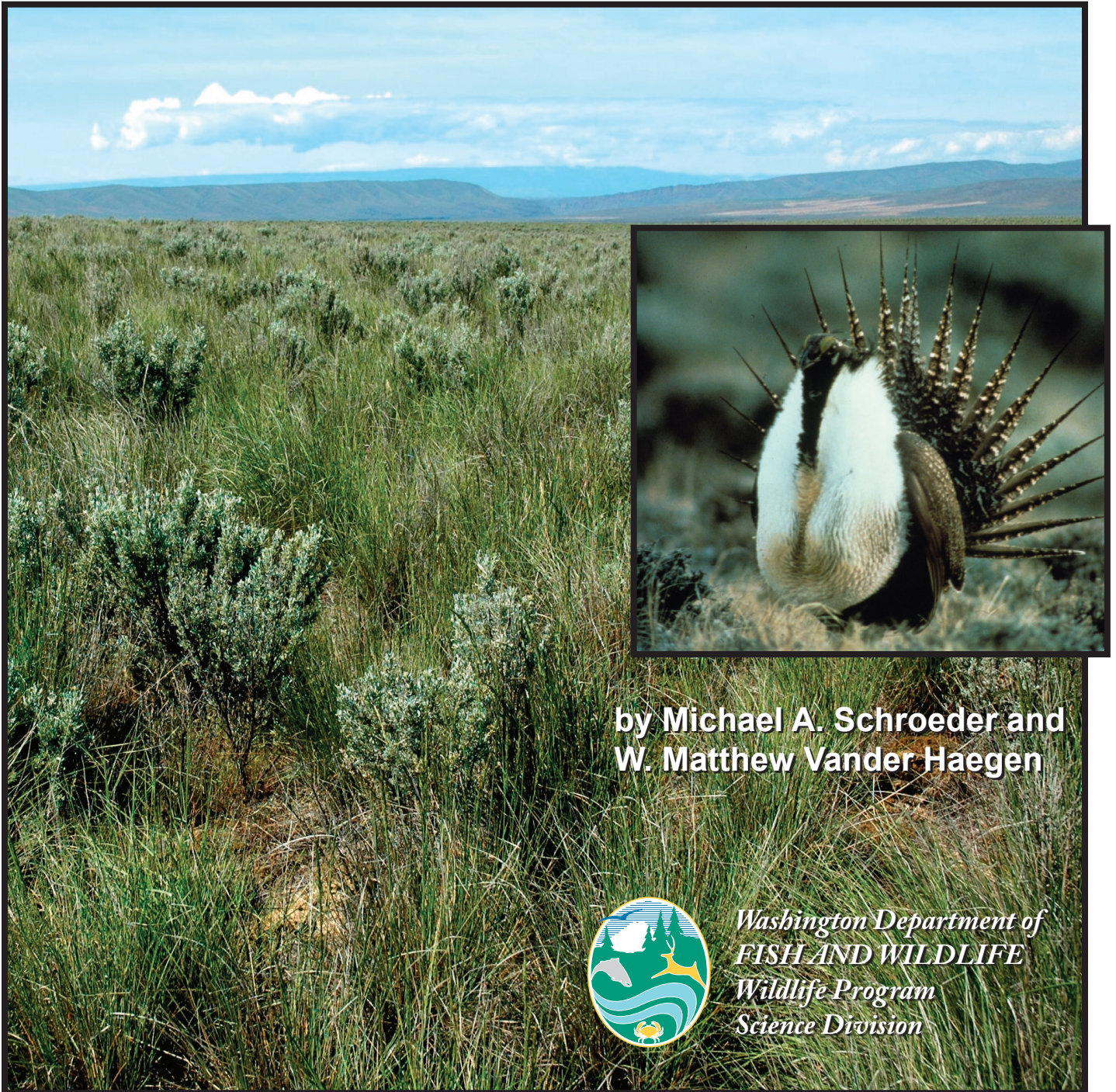

by Michael A. Schroeder and
W. Matthew Vander Haegen



*Washington Department of
FISH AND WILDLIFE
Wildlife Program
Science Division*

*Background photo by Matt Vander Haegen.
Greater sage-grouse by Robert E. Bennetts*

Use of Conservation Reserve Program Fields by Greater Sage-Grouse and Other Shrubsteppe- associated Wildlife in Washington State

Final report to
USDA Farm Service Agency

October 2006

Prepared by

Michael A. Schroeder (schromas@dfw.wa.gov)
W. Matthew Vander Haegen (vandemwv@dfw.wa.gov)

Washington Department of Fish and Wildlife
Wildlife Program, Science Division
600 Capitol Way North, Olympia, WA 98501

Recommended Citation:

Schroeder, M. A., and W. M. Vander Haegen. 2006. Use of Conservation Reserve Program fields by greater sage-grouse and other shrubsteppe-associated wildlife in Washington state. Technical report prepared for US Department of Agriculture Farm Service Agency. Washington Department of Fish and Wildlife, Olympia, WA.

CONTENTS

Executive Summary	4
<i>Background.....</i>	4
<i>Greater Sage-Grouse.....</i>	4
<i>Passerine Birds and Other Wildlife.....</i>	5
<i>Key Observations.....</i>	6
Introduction.....	6
<i>Habitat Change.....</i>	6
<i>Effects on Wildlife.....</i>	7
<i>Conservation Reserve Program.....</i>	9
<i>Scope of Report.....</i>	9
<i>Acknowledgements.....</i>	10
Methods.....	10
<i>Goals and Study Design.....</i>	10
Shrubsteppe/CRP Study: 2003-2005	10
Greater Sage-Grouse Research: 1955-2006.....	12
<i>Surveys for Passerine Birds.....</i>	13
Vegetation Sampling.....	13
Bird Abundance	14
Bird Productivity.....	14
Data Analysis.....	14
<i>Pellet Counts for General Species of Wildlife</i>	16
Surveys.....	16
Data Analysis.....	16
<i>Detailed Research on Greater Sage-Grouse</i>	17
Collection of Telemetry Data.....	17
Collection of Population Data.....	18
Data Analysis.....	18
Results	20
<i>Surveys for Passerine Birds.....</i>	20
Vegetation.....	20
Bird Abundance	21
Productivity.....	24
<i>Pellet Counts for General Species of Wildlife</i>	25
<i>Telemetry Research on Greater Sage-Grouse</i>	27
<i>Population Research on Greater Sage-Grouse</i>	29
Discussion.....	30
<i>Passerine Birds.....</i>	30
<i>Greater Sage-Grouse.....</i>	31
<i>Management Implications.....</i>	33
<i>Future Research.....</i>	34
Literature Cited	35

EXECUTIVE SUMMARY

BACKGROUND

The Conservation Reserve Program (CRP) is currently the largest-scale effort to restore grassland and shrubsteppe habitat in the Columbia River Basin. Administered by the Farm Service Agency (FSA) of the US Department of Agriculture, this voluntary program pays farmers to take agricultural lands out of production to achieve conservation objectives including reduced soil erosion and provision of wildlife habitat. In Washington, about 1.5 million acres (600,000 ha) of converted farmland has been planted to perennial grasses, forbs and shrubs under the CRP. Unlike CRP in the mid-west that largely occurs on land that was formerly prairie, much of the CRP in Washington occurs on land that was historically shrubsteppe. The current acreage of CRP land in eastern Washington is equal to about 10% of the state's total agricultural lands.

Declines in the abundance and quality of shrubsteppe have coincided with declines in the populations of many species including greater sage-grouse (*Centrocercus urophasianus*), sage thrashers (*Oreoscoptes montanus*), and Brewer's sparrows (*Spizella breweri*). While not an ideal solution to the problem of declining native habitat, CRP has enormous potential to provide habitat for many grassland and shrubsteppe species. Despite this potential, no studies have examined use of these CRP lands by grassland and shrubsteppe-obligate wildlife in the Columbia River Basin. The purpose of this research was to examine the relationship between wildlife and CRP in Washington, focusing primarily on the species closely adapted to shrubsteppe habitat.

GREATER SAGE-GROUSE

Between 1992 and 1997 we captured 89 female sage-grouse and monitored their nest site selection with the aid of radio telemetry. Although more nests were in shrubsteppe than CRP during the course of this study (59% vs. 41% of 203 nests), the proportion of nests significantly increased in CRP from 31% in 1992-1994 to 50% in 1995-1997. The increase appeared to be associated with maturation of CRP fields, which was characterized by increased height and cover of the perennial grasses and invasion by big sagebrush (*Artemisia tridentata*). The capability of CRP to successfully support nesting sage-grouse was further supported by the lack of differences in apparent success for nests placed in the two habitat types (45% success in CRP, 39% success in shrubsteppe). These observations were further supported with comparison of long-term rates of population change in sage-grouse in north-central Washington (approximately 17% of occupied area with CRP) and south-central Washington (approximately 2% of occupied area with CRP). Pre-treatment (prior to CRP) and treatment (following implementation of CRP) data revealed a slight reversal of a population decline in the north-central Washington population following implementation of CRP while the south-central population continued a long-term decline.

PASSERINE BIRDS AND OTHER WILDLIFE

From 2003 to 2005 we surveyed for wildlife on 48 study areas in agricultural/shrubsteppe landscapes of eastern Washington. We compared wildlife communities in 3 vegetation communities (old CRP, new CRP, and extant native shrubsteppe), each represented in landscapes dominated by agriculture and in landscapes dominated by shrubsteppe. We surveyed for passerine birds using point-count methods and for greater sage-grouse, mule deer (*Odocoileus hemionus*), jackrabbits (*Lepus* spp.), and cottontail rabbits (*Sylvilagus* spp.) using pellet-counts. We also examined nesting success of selected passerines in shrubsteppe landscapes by locating and tracking the fate of nests. We examined species abundance with models that included habitat type, landscape, and site-specific vegetation variables.

We counted 6710 birds during our point-count surveys. Numbers of birds counted in CRP fields were comparable to those counted in native habitat though the dominant species differed. Savannah sparrows (*Passerculus sandwichensis*), horned larks (*Eremophila alpestris*), and grasshopper sparrows (*Ammodramus savannarum*) generally dominated CRP fields; Brewer's sparrows, vesper sparrows (*Pooecetes gramineus*), and western meadowlarks (*Sturnella neglecta*) dominated shrubsteppe habitats. Grassland birds as a group were more abundant in CRP and also were more abundant in cropland-dominated landscapes. Shrubsteppe birds were most associated with extant shrubsteppe habitats and were more abundant in old CRP than in new CRP. Shrubsteppe birds used CRP fields only when sagebrush was present.

We were limited in our assessment of new CRP in that sagebrush had been planted on these study areas only since 1996. As the vegetation on these areas matures and shrub height increases they likely will see increased use by shrubsteppe passerines and sage-grouse. Old CRP fields with well-established sagebrush cover had numbers of Brewer's sparrows and sage thrashers comparable to that observed in native shrubsteppe. It is likely new CRP will support equivalent numbers of birds given an equal cover of mature sagebrush.

Nesting success of passerines in CRP was comparable to that of birds nesting in native shrubsteppe. Brewer's sparrows and vesper sparrows both showed similar rates of daily nest survival in new CRP, old CRP, and shrubsteppe, whereas savannah sparrows had greater rates of daily nest survival in CRP compared with native shrubsteppe.

Pellet surveys suggest that mule deer and jackrabbits are using CRP in fair numbers, with deer using New CRP and native shrubsteppe more than Old CRP and Jackrabbits using CRP in shrubsteppe landscapes more than in cropland landscapes. Cottontail rabbits appear to be using native shrubsteppe more than CRP regardless of landscape.

KEY OBSERVATIONS

- Shrubsteppe passerines are benefiting from CRP both through creation of suitable nesting habitat and development of a more contiguous “non-cropland” landscape where CRP adjoins fragments of native shrubsteppe.
- CRP was of most benefit to shrubsteppe-obligate passerines and to greater sage-grouse when it contained sagebrush and was located in a shrubsteppe landscape.
- CRP is providing suitable nesting habitat for some passerine birds and for sage-grouse—those species examined were equally successful at nesting in CRP fields compared to native shrubsteppe.
- CRP appears to be gaining in importance as nesting, brood-rearing, and wintering habitat for sage-grouse in Washington as the sagebrush matures.
- The greater sage-grouse population in north-central Washington, an area with abundant CRP, was the only population that demonstrated an average rate of increase. This increase corresponds with the development of CRP fields into habitat with abundant sagebrush.

INTRODUCTION

HABITAT CHANGE

Shrubsteppe communities historically dominated the landscape in eastern Washington (Daubenmire 1970). Daubenmire described shrubsteppe as vegetative communities consisting of one or more layers of perennial grass with a conspicuous but discontinuous overstory layer of shrubs. Although the dominant shrub is usually big sagebrush (*Artemisia tridentata*), other shrubs may also be common including threetip sagebrush (*A. tripartita*), gray rabbitbrush (*Chrysothamnus nauseosus*), antelope bitterbrush (*Purshia tridentata*), greasewood (*Sarcobatus vermiculatus*), and spiny hopsage (*Grayia spinosa*). Shrubsteppe is considered a ‘priority habitat’ within the state of Washington (<http://wdfw.wa.gov/hab/phshabs.htm>) that warrants special management considerations due to threats from human-associated causes.

Today, less than 50% of Washington’s historic shrubsteppe remains (Fig. 1), and much of it is degraded, fragmented, and/or isolated from other similar habitats (Jacobson and Snyder 2000, Vander Haegen et al. 2000). Conversion to cropland has resulted in the greatest loss of shrubsteppe in Washington, leading to a fragmented landscape and a

differentially high loss of deep-soil communities (Dobler et al. 1996, Vander Haegen et al. 2000). Similar large-scale conversion of shrubsteppe to cropland has occurred in north central Oregon, southern Idaho, and eastern Montana (Wisdom et al. 2000, Knick et al. 2003). Across the Intermountain West, shrubsteppe communities have been lost or degraded by conversion to cropland, extensive energy extraction, and alteration of the vegetation through over-grazing, invasion by exotic plants, and changes in fire frequency (Yensen et al. 1992, Pashley et al. 2000, Knick et al. 2003).

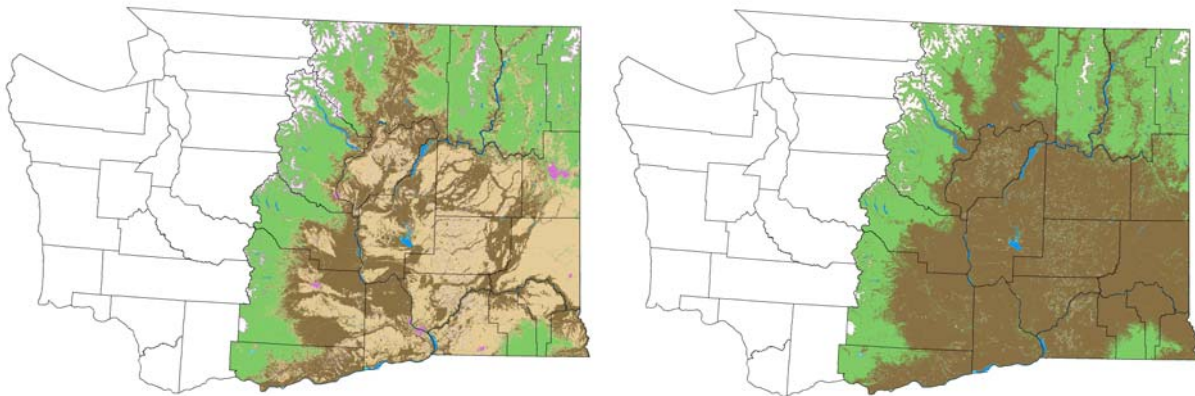

Fig. 1. Current (left) and historic (right) extents of shrubsteppe/grassland habitats in eastern Washington. Historic extents represent pre-European settlement and are based on soil/landcover relationships; current extents derived from analysis of Landsat Thematic Mapper data from 1993-1994. Within the images, green = forest cover, dark brown = shrubsteppe/grassland, tan = agriculture, blue = water, and magenta = urban.

EFFECTS ON WILDLIFE

Loss and degradation of extensive shrubsteppe communities has greatly reduced the habitat available to a wide range of shrubsteppe-associated wildlife including several birds restricted to this community type (Quigley and Arbelbide 1997, Saab and Rich 1997, Vander Haegen et al. 2000). Sage sparrows (*Amphispiza belli*), Brewer's sparrows (*Spizella breweri*), sage thrashers (*Oreoscoptes montanus*), and greater sage-grouse (*Centrocercus urophasianus*) are considered shrubsteppe obligates and numerous other species are associated primarily with shrubsteppe at a regional scale. In a recent analysis of birds at risk within the interior Columbia River Basin, most species identified as having a high management concern were shrubsteppe species. Moreover, according to the Breeding Bird Survey, half these species have experienced long-term declines in their populations (Saab and Rich 1997).

In recent decades populations of greater sage-grouse have declined throughout much of their range (Connelly and Braun 1997, Braun 1998, Connelly et al. 2004, Schroeder et al. 2004). These declines have been particularly dramatic in Washington, where sage-grouse have been reduced to 2 separate populations, one in north-central Washington and the other in south-central Washington (Fig. 2, Schroeder et al. 2000). The reduction of sage-

grouse in Washington has been caused by numerous factors, but foremost among them is the conversion of native sagebrush-dominated shrubsteppe to cropland, primarily for production of wheat (Yocom 1956, Swenson et al. 1987, Dobler et al. 1996, Schroeder et al. 2000). In addition, degradation of the remaining habitats, particularly those used for nesting and brood-rearing, is generally believed to have had negative impacts (Connelly et al. 1991, Gregg et al. 1994, Schroeder 1997, Connelly et al. 2000, Connelly et al. 2004).

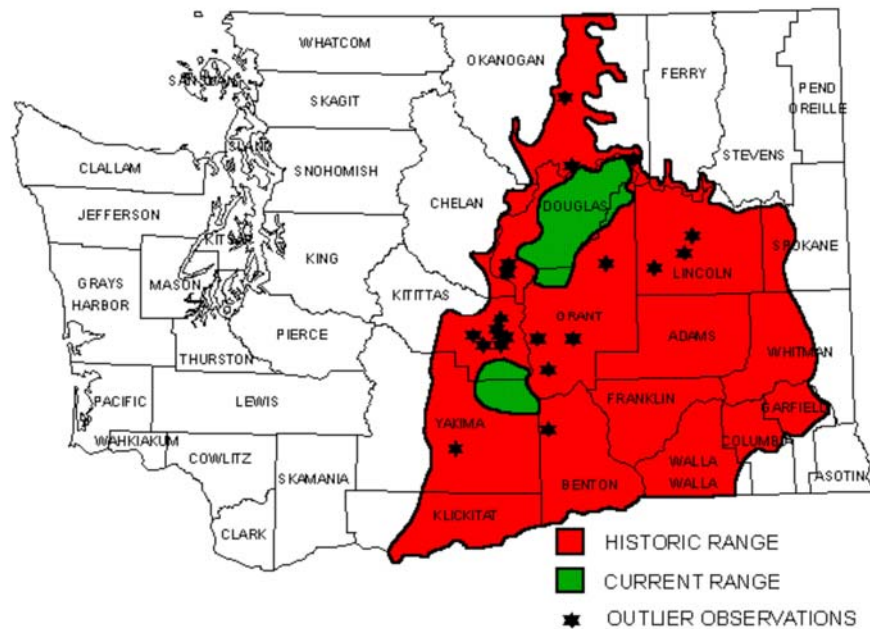

Fig. 2. Distribution of greater sage-grouse in Washington (Schroeder et al. 2000). Outlier observations were relatively infrequent and were believed to not represent current populations.

Previous work on shrubsteppe passerines in Washington has examined the relationship between various site-specific parameters and species occurrence and abundance (Rotenberry and Wiens 1980, Dobler et al. 1996, Vander Haegen et al. 2000). Sage sparrows are associated with less annual grass in the herbaceous layer, and grasshopper sparrows (*Ammodramus savannarum*) with more perennial grass. Brewer’s sparrows and sage thrashers are less abundant in shrubsteppe habitats of relatively poor quality (Vander Haegen et al. 2000). Habitat specific population parameters, including productivity, dispersal, and adult and juvenile survival, are unknown for most of these species. Fragmentation and degradation of shrubsteppe adversely affect some species, although relatively few have been studied. Sage sparrows are less abundant (Vander Haegen et al. 2000) and Brewer’s sparrows, sage sparrows, and sage thrashers are less productive (Vander Haegen et al. 2002, Vander Haegen 2007) in fragmented landscapes. Rates of parasitism by brown-headed cowbirds (*Molothrus ater*) were greater in fragmented shrubsteppe for Brewer’s Sparrows and resulted in fewer young fledged (Vander Haegen and Walker 1999, Vander Haegen 2007).

CONSERVATION RESERVE PROGRAM

The Conservation Reserve Program (CRP) is currently the largest-scale effort to restore grassland and shrubsteppe habitat in the Columbia River Basin. Administered by the Farm Service Agency (FSA) of the US Department of Agriculture, this voluntary program pays farmers to take agricultural lands out of production to achieve conservation objectives including reduced soil erosion and provision of wildlife habitat. In Washington as of July 2006 (http://www.fsa.usda.gov/dafp/cepd/crp_statistics.htm), 1,480,937 acres (599,314 ha) of converted farmland had been planted to perennial grasses, forbs, and shrubs under the CRP. The program allows farmers to periodically enroll lands for intervals of at least 10 years. Unlike CRP in the mid-west that largely occurs on land that was formerly prairie, much of the CRP in Washington occurs on land that was historically shrubsteppe. While not an ideal solution to the problem of declining native habitat, CRP has enormous potential to provide habitat for many grassland and shrubsteppe species. The current acreage of CRP land in eastern Washington is equal to about 10.3% of the region's total agricultural lands (<http://www.nass.usda.gov/>). Despite the potential of CRP land as wildlife habitat, no studies have examined use of these lands by grassland and shrubsteppe wildlife in the Columbia River Basin.

Studies in the mid-west have documented a variety of grassland birds using CRP fields (Patterson and Best 1996, Johnson 2000, Eggebo 2001). In Washington, grasshopper sparrows, Columbian sharp-tailed grouse (*Tympanuchus phasianellus*), and the greater sage-grouse are known to use CRP fields (WDFW unpubl. data) and there is the potential for use by other grassland birds such as short-eared owls (*Asio flammeus*), burrowing owls (*Athene cunicularia*), horned larks (*Eremophila alpestris*), and western meadowlarks (*Sturnella neglecta*). Although CRP fields have historically been planted to a variety of non-native grasses, more recently an increasing number of fields have been planted to native grasses, forbs, and native arid-land shrubs. Moreover, native shrubs (particularly big sagebrush) frequently seed-in from adjacent shrubsteppe, making some fields potentially usable by shrub-nesting species such as sage sparrows, Brewer's sparrows, and loggerhead shrikes (*Lanius ludovicianus*).

SCOPE OF REPORT

This report examines the use of CRP fields by wildlife in Washington, focusing on the shrubsteppe and grassland species most associated with the historical shrubsteppe habitat. Our focus also is on birds, because this group has received the most research attention in the recent past and includes numerous species of regional and national conservation concern. Our objective was to provide information that might be used to examine the potential of the CRP to aid in the conservation of these species.

The information in this report derives from two distinct sources: a research study conducted from 2003-2005 focusing on wildlife use of CRP and funded by the U.S. Fish and Wildlife Service and FSA; and past and ongoing research on the ecology of the greater sage-grouse conducted by WDFW and funded by the U.S. Fish and Wildlife

Service and WDFW. Results of these 2 studies are combined to present an evaluation of the value of CRP for shrubsteppe wildlife.

This report reflects the analyses that we have completed thus far and focuses on components of the Shrubsteppe/CRP study funded in part by FSA for the 2005 field season. Specifically, this includes completion of passerine bird surveys on 48 study areas, pellet sampling on 24 study areas (those within the current range of the greater sage-grouse), and incorporation of existing data from recent studies of sage-grouse in Washington State. As part of the larger study we also collected data on small mammals, reptiles, and the biological soil crust on the 48 study areas. Further, in 2006 under funding from FSA (among others) we extended our passerine and pellet surveys to an additional 410 study areas across eastern Washington. Results from these studies will be synthesized in a final report to all funding entities early in 2007.

ACKNOWLEDGEMENTS

The fieldwork that is represented here was accomplished with the aid of many more biologists than can possibly be mentioned here, in particular the survey work prior to 2003. The primary help during 2003-2005 was provided by D. Anderson, R. Bassar, S. Downes, C. Engleman, G. Gareau, M. Hill, W. Jessop, M.-F. Julien, S. Kies, J. Lawrence, L. R. Lillquist, S. Lundsten, A. Manning, J. Mason, J. McDonald, A. Peterka, L. A. Robb, D. Roediger, A. Sanfacon, J. Scales, A. Schmidt, J. Slotterback, and A. Spenceley. We thank Wan-Ying Chang for help with statistical analyses. We also received a great deal of cooperation from many landowners in the region that graciously permitted access to their lands. Substantial financial support was provided by the USDA Farm Service Agency, the U.S. Fish and Wildlife Service, and the Washington Department of Fish and Wildlife through the Federal Aid in Wildlife Restoration Project W-96-R. We thank C. Hagen, J. Connelly, S. Hyberg and J. Pierce for their thoughtful reviews of the report.

METHODS

GOALS AND STUDY DESIGN

Shrubsteppe/CRP Study: 2003-2005

The general goal of this research was to evaluate the potential role of CRP in the long-term conservation of obligate grassland and shrubsteppe wildlife in the Columbia River Basin. The specific objectives were to: 1) compare wildlife populations in CRP lands with those in nearby native shrubsteppe; 2) compare wildlife populations in CRP lands of different ages and in different landscape configurations; and 3) provide information to support management of CRP in Washington to benefit shrubsteppe-associated wildlife.

We compared wildlife communities in CRP fields with wildlife in native shrubsteppe. There were 6 “treatments”: 3 vegetation communities, each represented in landscapes

dominated by cropland and in landscapes dominated by shrubsteppe (Table 1). Study areas were grouped into 8 clusters; each cluster had six study areas, one of each treatment, for a total of 48 areas (Fig. 3). Shrubsteppe communities were dominated by native vegetation, with an overstory of big sagebrush and an understory of bunchgrasses and forbs. None of the shrubsteppe communities were currently grazed by livestock. “New” CRP communities were former agricultural lands planted after 1995 to a mix of non-native and native species including big sagebrush. “Old” CRP communities were former agricultural fields planted to non-native bunchgrasses prior to 1996 (most in late 1980s).

Table 1. Characteristics of 48 study areas surveyed for wildlife in eastern Washington, 2003-2005.

Vegetation community	Landscape	Code	N
Shrubsteppe	Shrubsteppe dominated	SS	8
Shrubsteppe	Cropland dominated	SC	8
New CRP (planted >1995)	Shrubsteppe dominated	NS	8
New CRP (planted >1995)	Cropland dominated	NC	8
Old CRP (planted <1996)	Shrubsteppe dominated	OS	8
Old CRP (planted <1996)	Cropland dominated	OC	8

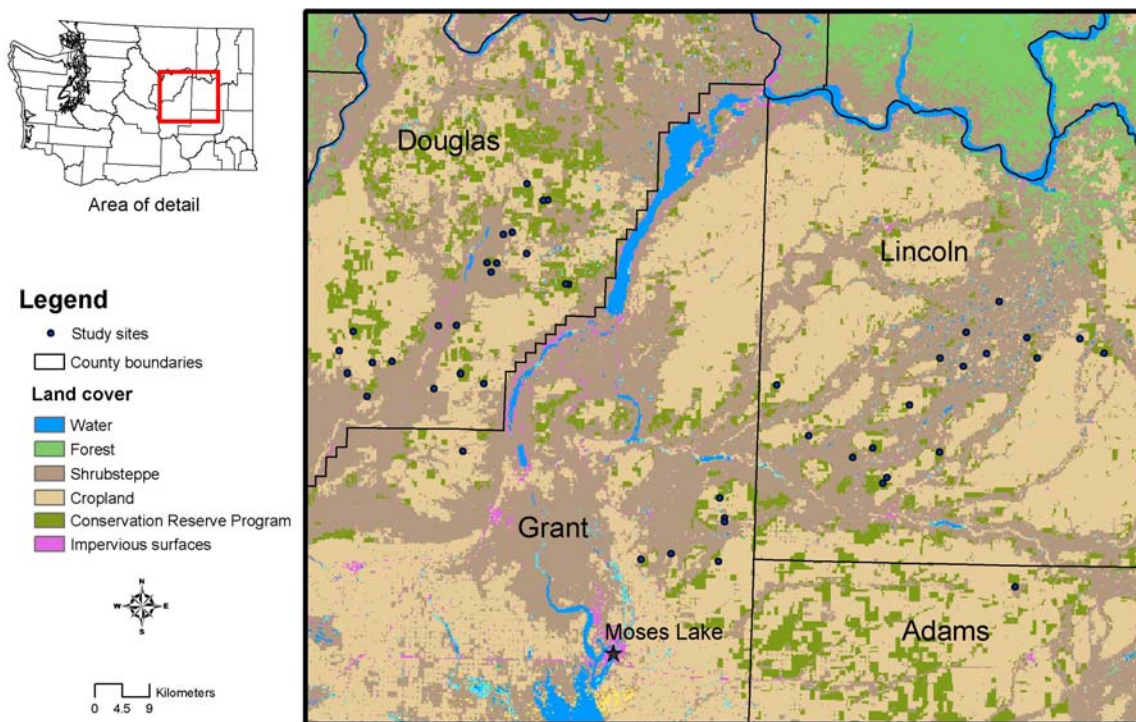

Fig. 3. Location of study areas in eastern Washington. Land cover was derived from Landsat imagery (1993-1994) and aerial photographs (CRP: 1996).

Each of the 48 study areas was 25 ha, usually buffered on the outside by at least 100 m of similar habitat to prevent obvious edge effects. Each study area contained 4 100-m fixed-radius circles spaced 300 m apart, thus providing a 100-m buffer between each circle perimeter (Fig 4). The 25-ha study areas, and the fixed-radius circles within them, were the focus of all survey work.

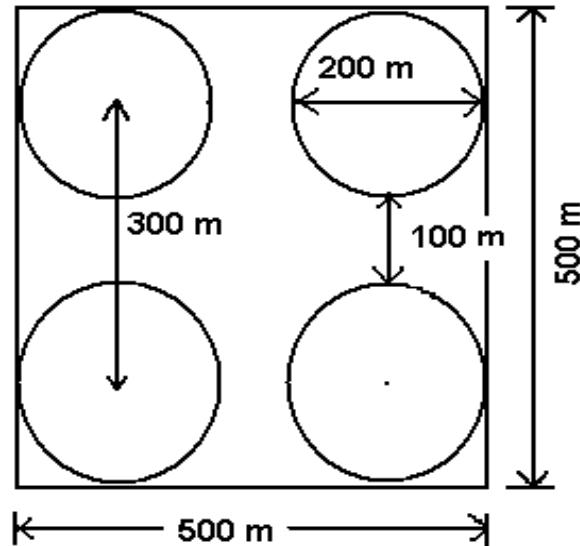

Fig. 4. Study area design illustrating the configuration of the four 100-m fixed-radius circles within the 25-ha square area. Each of 4 center points was marked with a permanent fiberglass stake; bamboo stakes were placed at 50 m and at 100 m from the point in each of the 4 cardinal directions to aid in determining distance during bird counts and to mark plots for pellet sampling.

Greater Sage-Grouse Research: 1955-2006

Primary habitats used by sage-grouse in Washington include shrubsteppe (Daubenmire 1970) and CRP (federal Conservation Reserve Program), as determined from research on radio-marked sage grouse (Schroeder 1997). Although sage-grouse are generally considered to be dependent on sagebrush (primarily big sagebrush, *Artemisia tridentata*) for food (particularly in winter) and cover (Schroeder et al. 1999), north-central Washington is one of the few areas where sage-grouse are found in an area with abundant CRP (Table 2, Schroeder et al. 2000). The abundance of CRP in north-central Washington during the course of the current study (2003-2005) was higher than values provided in Table 2 for the mid-1990s. In contrast, the sage-grouse population remaining in south-central Washington is in an area where CRP is uncommon.

The general goal of this research was to evaluate the role of CRP in the long-term conservation and management of greater sage-grouse in Washington. The specific objectives were to: 1) evaluate the use of CRP as a nesting habitat in north-central Washington; 2) evaluate the relative productivity of females nesting in CRP with those nesting in native shrubsteppe; and 3) compare rates of population change for sage-grouse in relation to the prevalence of CRP.

Table 2. Potential habitat quantity in relation to current and historic distribution of greater sage-grouse in Washington (Fig. 2, Schroeder et al. 2000).

Range or population	Proportion of area dominated by each habitat (%)				Total area (km ²)
	Shrubsteppe ^a	Cropland ^a	CRP ^b	Other ^a	
North-central Washington	44.3	35.1	16.7	3.9	3,529
South-central Washington	95.6	0.5	1.9	1.9	1,154
Total occupied range	57.0	26.6	13.0	3.4	4,683
Unoccupied range	42.3	42.8	5.5	9.4	53,058
Total historical range	43.5	41.5	6.1	8.9	57,741

^aLandsat Thematic Mapper, 1993.

^bDetermined from aerial photos dated 1996.

SURVEYS FOR PASSERINE BIRDS

Vegetation Sampling

Vegetation on each study area was measured within 15 m x 6.67 m (100 m²) vegetation plots located within each of the four 100-m fixed-radius circles within each study area (Fig. 4). Each quadrant was ‘anchored’ at a point a random distance and bearing from the center of each center and positioned in a random direction. If a second vegetation community was present within the 100-m fixed-radius circle, a second plot was selected within the additional habitat type. Thus, from 4 to 8 vegetation plots were measured at each study area. All sampling was completed in June and July of 2003.

All plant species observed within vegetation plots were recorded and their cover visually estimated as one of 9 values: 1) 1% or less; 2) >1-5%; 3) >5-15%; 4) >15-25%; 5) >25-35%; 6) >35-50%; 7) >50-75%; 8) >75-95%; and 9) >95%-100%. Colored flags were placed at set distances along the plot boundary to assist with cover estimates. Percent cover for general vegetation/substrate categories also was estimated, including shrubs, small shrubs, perennial grasses, annual grasses, forbs, rock/gravel, standing dead, bare ground, soil crust, and litter. For this study, ‘litter’ was defined as dead plant material that was detached and laying on the ground and ‘standing dead’ was defined as dead plant material attached, above the ground, and/or not being replaced by new seasonal growth. Cover value was recorded in 2 different ways: 1) only the top vegetation/substrate layer where overlap was not considered (totaling 100%) and 2) all vegetation/substrates regardless of their overlap (usually totaling > 100%). The maximum height was recorded for each category (nearest cm), other than bare ground, soil crust, and litter.

Density of shrubs was recorded within a randomly selected quarter (3.75 x 6.67 m) of each vegetation plot. The number of each species was recorded by category: juvenile (small, flexible, and non-reproductive plant) or mature (relatively large reproductive

plant). Robel pole readings (Robel et al. 1970) were recorded on each of 10 points along the perimeter of the sampling plot. Readings were taken at a height of 1 meter and at a distance of 4 m from the inside of the plot looking toward the outside.

Bird Abundance

We surveyed birds using fixed-radius point-counts (Ralph et al. 1993) centered on each of the four points (Fig. 4) on each of the 48 study areas. Each area was surveyed twice (May and June) and in each of the 3 years. Counts at each point were 5 minutes in duration during which all birds seen or heard were noted, along with their sex (if known), distance from the point (within 50 m, >50 but <100 m, or beyond 100 m), and behavior (singing, calling, silent, or flying over the circle). Counts were only conducted within prescribed weather parameters (i. e., no rain and low wind). A crew of between 6 and 8 biologists trained in bird identification conducted the surveys each year. Each biologist surveyed an equal number of study areas in each of our 6 “treatments”, minimizing the effects of potential observer bias.

Bird Productivity

We measured reproductive parameters on all 24 study areas in shrubsteppe landscapes (OS, NS, SS). Habitats in cropland landscapes (and thus a landscape comparison) were excluded because of existing work on the effects of landscape fragmentation on nesting success of shrubsteppe passerines (Vander Haegen et al. 2002, Vander Haegen 2007) and the enormous effort required to obtain this type of data. We located nests by following behavioral cues (e.g., adults carrying nest material or food) and by searching likely areas of the 25-ha study plots. Once found, nests were marked with a single piece of colored flagging placed ≥ 8 m distant, and status (number of eggs/young) was noted. We visited nests every 3-4 days until fledging or failure. We considered a nest to have fledged when 1) the nest was empty and we saw fledglings near the nest or adults were seen nearby carrying food and/or scolding, or 2) the nest was empty and the median date between the last nest check during which the nest was active and the final nest check when the nest was empty was within 2 days of the predicted fledging date (BBIRD protocol; pica.wru.umt.edu/BBIRD/protocol/monitor.htm). We defined successful nests as those that fledged ≥ 1 host young.

Data Analysis

We used the bird survey data to derive an estimate of annual abundance for each species on each study area. Analysis was limited to birds seen or heard within each 100-m fixed-radius circle and excluded birds observed only flying over the circle. We used the maximum number of individuals recorded on a single survey as an estimate of annual abundance for each species at each point and we averaged these values among the 4 points at each area. We examined the influence of habitat and landscape variables on bird abundance using generalized linear mixed models (PROC GLIMMIX; SAS Institute 2006). We modeled the data under a Poisson distribution and incorporated random effects for year and study area. We included five fixed terms in the full models: Habitat type (new CRP, old CRP, or shrubsteppe), landscape (cropland or shrubsteppe), shrub

cover (percent cover in shrubs) grass cover (percent cover in perennial grasses), and forb cover (percent cover in perennial forbs). The two categorical variables represent the main effects the study was designed the test, whereas the 3 continuous variables represent key vegetative components that have been shown in the past to influence use by shrubsteppe and grassland birds (Wiens and Rotenberry 1981, Vander Haegen et al. 2000) or that were of specific interest to this study.

Our modeling approach was to use both maximum counts at each point and annual study area means as response variables in separate model sets. Area-level models included either 'area' as a random variable (treating year as a repeated measure) or they included Cluster x Year as a random variable to test the possibility that study areas within each geographic cluster might be more closely related than those between clusters. Point-level models included a random term for Area x Year (treating year and study area as repeated measures) or they assumed independence among points and had no random term (the simplest model). Within each of these model sets we developed models for the 8 most common species and for 2 species groups: grassland specialists (savannah sparrow [*Passerculus sandwichensis*], grasshopper sparrow, western meadowlark, and horned lark) and shrubsteppe specialists (Brewer's sparrows, sage sparrows, and sage thrasher). Vesper sparrows (*Pooecetes gramineus*), because of their more generalist habitat affinities that have them associated with grasslands in some areas and woody vegetation in others (Vander Haegen et al. 2000, Jones and Cornely 2002), were not included in either group. Study areas from 2 clusters were removed from the dataset for sage sparrow because they were beyond the expected range of the species based on previous surveys (WDFW Unpubl. data). We examined the model fit statistics for all models and present those models that best fit the data, including at least one model from each model set where appropriate. After preliminary analysis the variable for percent cover in shrubs was found to be highly correlated with Habitat type and Landscape and was removed from the models.

We used the logistic-exposure method of Shaffer (2004) to examine habitat and landscape effects on the fates of individual nests. Logistic regression has the benefit of including both categorical and continuous variables in modeling a dichotomous outcome variable, in this case, nest fate (Hosmer and Lemeshow 2000). Logistic-exposure accounts for the differing exposure periods among nests by using nest-observation intervals as sample units and incorporating interval length in a modified link function (Shaffer 2004). The dataset included all nests where eggs were laid and that appeared to be active. We excluded nests that were abandoned immediately following extreme weather events (e.g., severe rain or hail) and those that were abandoned immediately following parasitism by brown-headed cowbirds (both total < 1%).

We developed models for 3 species with the greatest sample sizes (Brewer's sparrow, savannah sparrow, and vesper sparrow) using PROC GENMOD (SAS Institute 2006). We included 6 terms in each model: Habitat type (new CRP, old CRP, or shrubsteppe), percent cover in shrubs, perennial grasses, and perennial forbs, year, and Julian day (the last day in each exposure period). The categorical variable represents the main effect the study was designed the test; the vegetation and temporal variables were included to control for these effects but will not be discussed further here (more detailed modeling of

vegetation and temporal effects will follow in a later report). We calculated daily nest survival rates using *estimate* statements in GENMOD.

We used diagnostics within the GENMOD procedure to examine standardized deviance residuals for the global model, where large values (≥ 3) would suggest outliers. We used the REG procedure (SAS Institute 2006) to examine multi-collinearity of continuous variables in the global model (Allison 1999). No models showed indications of significant outliers or multi-collinearity.

PELLET COUNTS FOR GENERAL SPECIES OF WILDLIFE

Surveys

Pellet counts were conducted at cardinal directions 50 m from each of 4 center points in each study area (16 pellet counts for each study area). We counted pellets within circular 50-m² plots centered on each of the 50-m flags. Each 50-m² area was delineated with the aid of a 4-m string looped over a center stake. By walking the perimeter at the end of the string, the observer was able to identify pellets that were in or out of the circle. In the case of mule deer (*Odocoileus hemionus*) pellet groups, the group was counted as being ‘in’ if at least half the pellets in the group were in the circle. Once the perimeter was established, pellets clearly within the circle were identified and counted. All pellets observed were removed from the circle to aid in repeat visits.

Pellet counts were conducted on the 24 western study areas (Fig. 3) since most were within or close to the established range of the greater sage-grouse in Washington (Fig. 2, Schroeder et al. 2000). In contrast, none of the 24 eastern study areas was within the established distribution of sage-grouse. Each of the 384 plots (16 plots on each of 24 study areas) was examined in October 2004 and again in April 2005. Although the April 2005 count provided some opportunity to examine the frequency of pellet deposition, the durability of pellets to weather, and the likelihood of missing pellets in previous counts, the data were not examined for these possibilities here. It must be realized that it was impossible to avoid missing some pellets. Many pellets (e.g., cottontails) were small and difficult to see. In addition, many were covered by vegetation and or deteriorated to the point that they were difficult to differentiate from the background soil and vegetation.

Pellets were recorded based on general appearance (WDFW, unpubl. data). We quantified pellets left by greater sage-grouse, sharp-tailed grouse, jackrabbits (*Lepus* spp.), cottontail rabbits (*Sylvilagus* spp.), mule deer, and “other game birds”. For deer, pellet groups were counted (those with >6 pellets); for other species individual pellets were counted.

Data Analysis

We examined pellet numbers (or pellet groups in the case of deer) at the study area level ($n = 24$) using the total count for the 4 plots associated with all 4 center points on each study area (summation of 16 plots). We used ANOVA and Friedman’s nonparametric ANOVA to examine effects of Habitat type and Landscape on total count. Deer pellets

occurred on all areas and the data appeared to have a somewhat normal distribution; other species had numerous zero counts and were not normally distributed. We also used general linear models to examine pellet counts at the level of the individual point (n = 96 circles) so that we could include a measure of vegetation density to help control for potential difference in detectability among points; however, models with a random term for plot (necessary to account for lack of independence among points at each study area) failed to converge. We also examined presence/absence at each study area using logistic regression with a random term for area and a measure of vegetation density; this model converged only for jackrabbits.

DETAILED RESEARCH ON GREATER SAGE-GROUSE

Collection of Telemetry Data

Some of the following methods were described in detail in Schroeder (1997). Greater sage-grouse were studied on a 3,000 km² area centered near Mansfield, Washington. Female sage-grouse were trapped on seven different display sites (leks) with the aid of walk-in traps (Schroeder and Braun 1991) during March and April, 1992-1996. Sex and age were determined for all captured birds (Beck et al. 1975); all females were fitted with battery-powered radio transmitters attached to poncho-like collars (Amstrup 1980) or necklaces.

Females were located with a portable receiver and 4-element Yagi antenna at least once every three days to collect data on the location and success of nests. Most females were located either visually or with triangulation techniques designed to determine whether the female was on her nest. Variation in intensity of transmitter signals also was used as an indication of female behavior; radio transmitters emitted a constant signal when a female was on her nest and a variable signal when she was walking or flying. Fixed-wing aircraft were used to locate “lost” birds.

‘Visual’ observations of females on nests consisted of triangulation from a distance of about 30 m from the nest site; this minimized disturbance of females and usually allowed nest sites to be located following hatch or failure. Females were considered to have nested successfully if at least 1 egg hatched. Analyses of nest success and habitat selection were conducted with logistic regressions (Proc CATMOD, SAS Institute 2006). Most nests were located during laying or early in incubation and thus exposure period differed little among nests.

Specific characteristics of habitat were also recorded at nest sites. A ‘visual obstruction’ reading was recorded with the aid of a Robel pole (Robel et al. 1970) at 20 different locations for each nest site; 1, 3, 5, 7, and 9 m from the nest site at 4 cardinal directions. The visual obstruction readings were taken from a distance of 4 m from each point (perpendicular to the cardinal direction) and at a height of 1 m. Cover of shrubs, grasses, forbs, and bare ground were estimated ocularly to the nearest 5% within 10 m of the nest site. Height of the tallest shrub was also recorded to the nearest cm. Species diversity

was recorded as the number of different plant species identified within 10 m of the nest site in a 10-minute period.

Collection of Population Data

Although greater sage-grouse were historically found throughout much of eastern Washington, surveys conducted between 1955 and 2006 suggest that only 3 populations have existed during that time interval (Schroeder et al. 2000). These include a population primarily in north-central Washington (Moses Coulee area of Douglas County), a population in south-central Washington (primarily on the U.S. Army's Yakima Training Center [YTC]) in Yakima and Kittitas counties), and a population primarily in Lincoln County. Because the population in Lincoln County has been extinct since the mid-1980s, it was not considered in the primary analysis here. The north-central Washington and Lincoln County populations have been monitored regularly since 1955 and the south-central Washington population has been monitored since 1970. In order to make comparisons between the 2 areas consistent, only data collected since 1970 was used in the primary analysis that follows.

Male sage-grouse congregate on lek sites during spring to perform breeding displays and to mate with females (Schroeder et al. 1999). Although most lek sites are traditional, some leks occasionally change or 'shift' locations, as documented with observations of marked individuals between years. In addition, some males attend temporary 'satellite' leks until they become established on relatively permanent 'core' leks. Many of these specific sites form clusters defined here as 'lek complexes'. Although the definition of lek complexes is somewhat arbitrary, lek sites within a complex are usually < 3 km from one another. Lek complexes are clearly spatially separated from adjacent lek complexes by > 6 km.

We surveyed lek complexes between 1970 and 2006 to obtain information on sage-grouse populations and annual rates of change (similar to an earlier analysis by Schroeder et al. 2000). The survey protocol included searches for new and/or previously undiscovered complexes and multiple (≥ 3) visits to specific complexes. Some original data from the 1970s were lost so that only single 'high' counts remain, despite many complexes having been observed on more than one occasion. During 1992-2006, personnel of the Washington Department of Fish and Wildlife and the U.S. Army attempted to visit all sage-grouse lek complexes in Washington on ≥ 3 occasions each year.

Data Analysis

We used logistic regression (Hosmer and Lemeshow 2000) to examine the likelihood of a nest occurring in CRP versus other vegetation types (primarily shrubsteppe or wheat fields). The outcome variable was "CRP" or "other" and there were 3 explanatory variables: female age (adult or yearling), order of the nest (first nest or reneest), and year (1992 through 1997). We also used logistic regression to test if habitat type influenced nest success, with nest fate (successful or failed) as the outcome variable and 3 explanatory variables: habitat (CRP or shrubsteppe), female age (adult or yearling), and

order of the nest (first nest or re-nest). Variables describing vegetation structure were not included in this analysis because measurements were not taken at all nests. We tested for model fit using the Hosmer-Lemeshow test (Hosmer and Lemeshow 2000). We tested for differences in vegetation at the nest site between nests in CRP and nests in shrubsteppe using t-tests. Percentage data were arcsin-transformed prior to analysis to improve normality and then converted back to percentages for presentation. We also considered the influence of multiple comparisons when evaluating significance values.

Numbers of males attending lek complexes were analyzed using the highest number of males observed on a single day for each complex for each year. Although this technique is used throughout the North American range of greater sage-grouse (Connelly et al. 2004), it may have numerous biases (Jenni and Hartzler 1978, Emmons and Braun 1984, Walsh 2002, Walsh et al. 2004). First, yearling males appear to visit lek complexes less frequently than adults. Second, the number (or proportion) of yearlings in the population is unknown. Third, attendance at complexes tends to peak relatively late in the breeding season. Fourth, the number of males not visiting lek complexes is unknown. Fifth, the maximum count of males on a lek complex tends to be positively correlated with the number of counts. Sixth, some males (particularly yearlings) visit more than 1 lek complex within a breeding season. All but the last of these potential biases would tend to produce relatively low estimates of the number of males in the population. Despite these potential biases, lek counts also may provide an effective and verifiable assessment of a population's long-term trends (Connelly et al. 2004). Annual rates of population change were estimated by comparing the total number of birds counted at lek complexes in consecutive years. Because sampling was occasionally biased by effort and/or size and accessibility of leks, those not counted in consecutive years were excluded from the sample for a given interval (Connelly et al. 2004). Annual instantaneous rates of change for each population were estimated as the natural logs of the males counted on leks in year x divided by the males counted on the same leks in year $x-1$ (only leks counted in consecutive years were used for each annual estimate).

Because CRP was authorized in 1986, the analysis of population data in Washington permitted a comparison of pre-treatment data (before CRP) with treatment data (after CRP). However, because the implementation of CRP was not instantaneous, we eliminated some of the transition years to avoid confusion. Radio telemetry research on sage-grouse (data presented in results below) showed that sage-grouse were using CRP in north-central Washington in 1992, and that the level of use was increasing each year. Because CRP was not usable in 1987 (the year most of the first fields were planted), we did not consider data for population changes between 1988 and 1992 in subsequent analyses (the five years of data represents 4 annual intervals of population change). The pre-treatment years included 1970 through 1988 (18 annual rates of change). Because the planted CRP fields resembled wheat fields during their first year, we believe it was justifiable to use the 1987-1988 interval as the last pre-treatment interval. The treatment years included 1992 through 2006 (14 annual rates of change). Because of the small amount of CRP in the range of the south-central Washington population of sage-grouse (Table 2), we treated that population as a control.

RESULTS

SURVEYS FOR PASSERINE BIRDS

Vegetation

Percent shrub cover ($P < 0.001$) and shrub height ($P = 0.009$) differed among classes with greatest values in the native shrubsteppe types and Old CRP in a shrubsteppe landscape (Table 3). Shrub cover and shrub height did not differ significantly among the 4 CRP types. Height of perennial grass differed among classes ($P = 0.0019$) with the greatest values in New CRP. Height of perennial grass in native habitat in a shrubsteppe landscape was lower than that in New CRP. Both percent cover in bare ground ($P = 0.047$) and the mean robel pole reading ($P = 0.033$) differed among classes; however, no pair-wise comparisons were significant.

Table 3. Summary of vegetative characteristics at 48 study areas in north-central Washington.

Variable	Shrubsteppe landscape			Cropland landscape		
	Shrubsteppe	New CRP	Old CRP	Shrubsteppe	New CRP	Old CRP
	Mean ^a (SE)	Mean (SE)	Mean (SE)	Mean (SE)	Mean (SE)	Mean (SE)
Perennial grass (% cover)	68.62 (4.03)	73.04 (9.04)	74.21 (6.60)	69.73 (1.44)	69.26 (5.82)	76.30 (4.37)
Perennial grass (height cm)	37.65a (2.42)	57.74b (5.36)	42.48ab (2.36)	47.33ab (3.60)	55.88b (3.99)	48.18ab (2.27)
Perennial forb (% cover)	4.10 (0.71)	15.36 (12.14)	2.95 (0.91)	4.38 (1.17)	9.64 (5.59)	3.09 (1.03)
Shrubs (% cover)	19.64a (3.37)	2.09bc (1.55)	8.55abc (3.52)	11.94ab (1.71)	1.87bc (1.84)	1.45c (0.92)
Shrubs (height cm)	109.38a (6.59)	30.47b (11.06)	77.29ab (12.29)	96.53a (5.69)	28.44ab (17.70)	52.19ab (16.75)
Robel pole (height cm)	10.28 (1.99)	6.91 (1.08)	5.44 (1.16)	11.98 (2.26)	8.97 (1.74)	5.30 (1.02)
Bare ground (% cover)	2.45 (0.54)	0.96 (0.18)	1.65 (0.81)	2.67 (0.98)	1.20 (0.45)	1.51 (0.83)

^a Means followed by like letters were not significantly different (Wilcoxon test, $P < 0.05$ with correction for multiple comparisons, following a significant [$P < 0.01$] Kruskal-Wallis test for the variable across all classes).

The dominant perennial grasses in CRP were *Agropyron cristatum* in Old CRP habitats and *Poa ampla* in New CRP habitats. Native shrubsteppe sites were dominated by *P. secunda*; other common grasses in native shrubsteppe included *Pseudoroegneria spicata*, *Stipa comata*, and *Festuca idahoensis*. Common forbs in Old CRP included *Achillea millefolium* (common yarrow), *Tragopogon dubius* (yellow salsify), and *Lupin* sp. Common forbs in New CRP included those mentioned above and *Medicago sativa* (alfalfa). Native shrubsteppe sites supported a very diverse forb community.

Bird Abundance

We counted a total of 6710 individual birds that fit our criteria during point-count surveys: 2309 in 2003, 2462 in 2004, and 1939 in 2005. Counts of total birds in each of the 6 treatment classes were similar and exceeded 1100 individuals over the 3 years (Fig. 5). The dominant species, however, varied among classes with savannah sparrows dominating in new CRP at one end of the spectrum and Brewer's sparrows dominating in native shrubsteppe (Fig. 5). There was a general pattern of grassland species dominating CRP habitats and shrubsteppe species dominating native habitats.

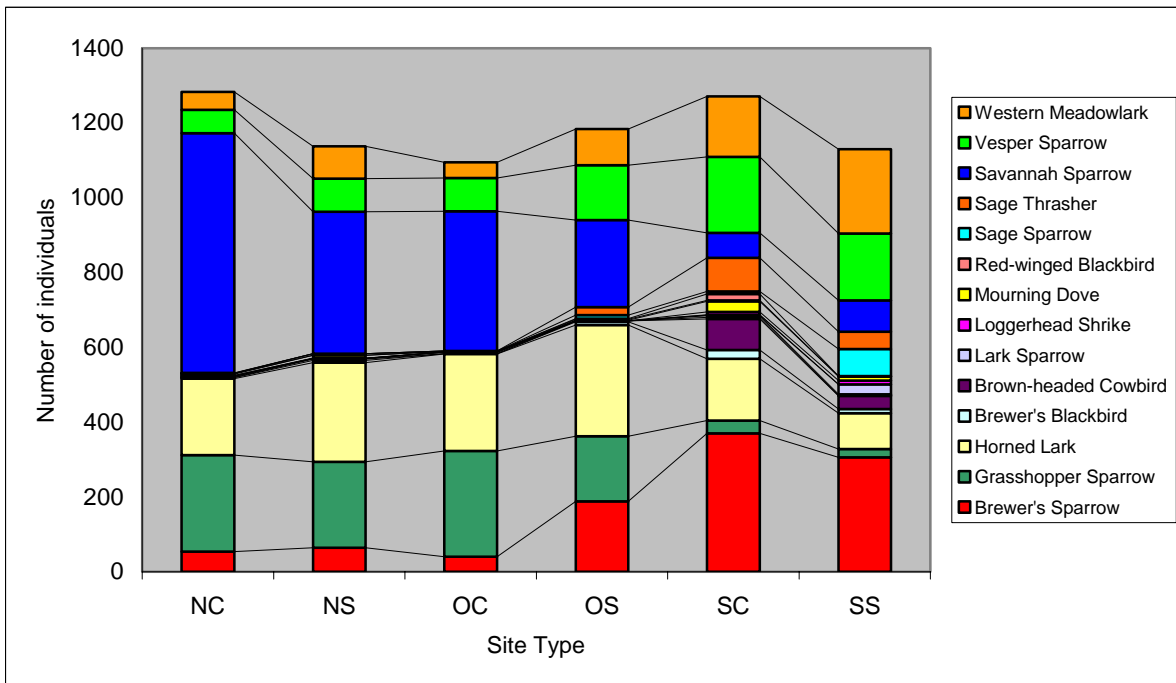

Fig. 5. Number of individual birds counted on 100-m fixed-radius point count surveys in eastern Washington, 2003-2005. Habitat/landscape codes are NC (new CRP in cropland landscape), NS (new CRP in shrubsteppe landscape), OC (old CRP in cropland landscape), OS (old CRP in shrubsteppe landscape), SC (native shrubsteppe in cropland landscape), and SS (native shrubsteppe in shrubsteppe landscape). Legend does not show all species counted.

Brewer’s sparrows, sage sparrows, and sage thrashers all occurred in CRP, but mostly habitats that contained mature sagebrush plants and in native landscapes. Brewer’s sparrows made most use of CRP in Washington, occurring in all 4 CRP Habitat types. Shrubsteppe habitats also had the most diverse bird communities (Fig. 5) with 19-21 species known to nest in shrubsteppe/grassland communities compared to 10-11 species in the 4 CRP habitat types.

The modeling results indicate a strong trend towards grassland species being more abundant in CRP and in cropland landscapes (Table 4). Within CRP, grassland species as a group were more abundant in New than in Old and this relationship also was significant for savannah sparrows; for horned larks, the opposite pattern occurred. Grassland birds were mixed in their response to the vegetation variables in our analysis with savannah sparrows strongly associated with percent cover of perennial grasses and grasshopper sparrows negatively associated with percent cover in perennial forbs. Horned larks were negatively associated with percent cover of perennial forbs in the point-level model and perennial grasses in the area-level model.

Table 4. Results of general linear models of bird abundance as a function of site, vegetation, and landscape variables.

Species	Model ^a	Covariates ^b	Direction of effect ^c	F	P	-2 LL	χ^2
Brewer’s sparrow	1	Habitat	Native > (Old > New)	9.92	0.0003	415.9	60.8
	2	Pergscov	—	5.00	0.027	1759	352
Grasshopper sparrow		Habitat	Native > Old > New	24.5	<0.0001		
	1	Habitat	(New, Old) > Native	16.53	<0.0001	337.13	35.9
	2	Perfrbcov	—	2.79	0.0971	1657	329
		Habitat	(New, Old) > Native	36.5	<0.0001		
		Landscape	Cropland > Shrubsteppe	5.01	0.0268		
Horned lark	1	Perfrbcov	—	5.38	0.0253	302.5	59.6
		Habitat	(Old > New) > Native	7.68	0.0014		
	2	Pergscov	—	9.63	0.0023	1460	429.0
		Habitat	Old > New > Native	13.75	<0.0001		
Sage sparrow	3	Habitat	Native > Old	3.65	0.0301	54.5	23.9
		Landscape	Shrubsteppe > Cropland	7.39	0.008		
Sage thrasher	1	Habitat	Native > (Old > New)	2.49	0.0947	1049	266.8
	2	Habitat	Native > (Old > New)	3.05	0.0505	4933	4069

Continued.

Table 4. Continued.

Species	Model ^a	Covariates ^b	Direction of effect ^c	F	P	-2 LL	χ^2	
Savannah sparrow	1	Pergrscov	+	3.64	.06034	333.07	50.79	
		Habitat	New > Old > Native	9.63	0.0004			
		Landscape	Cropland > Shrubsteppe	3.34	0.0749			
	2	Pergrscov	+	9.61	0.0023	1624.2	503.67	
		Habitat	New > (Old > Native)	25.44	<0.0001			
		Landscape	Cropland > Shrubsteppe	8.81	0.0035			
Vesper sparrow	1	Habitat	Native>(Old>New)	3.71	0.0328	371.19	44.88	
		Habitat	Native > Old > New	9.06	0.0002			
	2	Pergrscov	—	3.4	0.0674	1754.9	393.22	
		Habitat	Native > Old > New	9.06	0.0002			
Western meadowlark	1	Habitat	Native > (Old, New)	14.98	<0.0001	367.63	53.89	
		Landscape	Shrubsteppe > Cropland	5.91	0.0194			
	2	Habitat	Native > (Old, New)	22.38	<0.0001	1845.4	463.04	
		Landscape	Shrubsteppe > Cropland	8.83	0.0035			
	Grassland birds ^d	1	Habitat	(New, Old) > Native	15.17	<0.0001	154.16	58.29
			Habitat	New > Old > Native	60.26	<0.0001	777.59	402.87
Landscape		Cropland > Shrubsteppe	6.89	0.0729				
Shrubsteppe birds ^e	1	Habitat	Native > (Old > New)	14.58	0.0001	411.66	70.32	
		Habitat	Native > Old > New	35.30	<0.0001			
	2	Pergrscov	—	5.78	0.0175	1715	379.19	

^aModels: 1. Abundance = average of maximum counts at each of 48 study areas for each of 3 years ($n = 144$), Poisson regression with random effect of area (repeated measure on year); 2. Abundance = maximum count at each of 4 points for each of 48 study areas for each of 3 years ($n = 576$), Poisson regression with random effect of area \times year; 3. Abundance = maximum count at each point (4 points/area), no random term.

^bHabitat type: Native = shrubsteppe habitat, New = CRP planted after 1995, Old = CRP planted prior to 1996. Landscape: dominated by shrubsteppe or cropland. Pergrscov = percent cover in perennial grasses and Perfrbcov = percent cover in perennial forbs.

^cParameter estimates for variables within parentheses did not differ significantly ($P < 0.01$); parameter estimates that appeared to be of similar magnitude are separated by commas.

^dGrassland birds include savannah sparrow, grasshopper sparrow, and western meadowlark.

^eShrubsteppe birds include Brewer's sparrow, sage sparrow, and sage thrasher.

Shrubsteppe birds were more abundant in shrubsteppe than in CRP but their relationship with landscape was mixed (Table 4). Sage sparrows were strongly associated with native landscapes, whereas both Brewer's sparrows and sage thrashers showed no strong landscape relationships. Within CRP, shrubsteppe birds were more abundant in Old than New habitats and this relationship was evident for Brewer's sparrows and sage thrashers; sage sparrows did not occur in any New CRP habitats. Only 4 of the 8 Old CRP study areas in shrubsteppe landscapes had shrub cover > 5%, thus the mean abundance values for shrubsteppe birds in this Habitat/landscape type is biased somewhat low. Mean abundance values for the 4 Old CRP habitats with shrub cover exceeds that for the unfragmented shrubsteppe habitats for Brewer's sparrows and is close to the value for the unfragmented shrubsteppe habitats for sage thrashers. As a group, shrubsteppe birds had a negative response to percent cover in perennial grasses and this relationship also was evident in individual models for Brewer's sparrows and vesper sparrows.

Productivity

We found and tracked the fates of 657 Brewer's sparrow nests (115 in 2003, 208 in 2004, and 334 in 2005), 224 savannah sparrow nests (61 in 2003, 117 in 2004, and 46 in 2005), and 202 vesper sparrow nests (58 in 2003, 72 in 2004, and 72 in 2005). Rate of parasitism by brown-headed cowbirds was low (<3%) and those few parasitized nests were excluded from the analysis of nest success. Most (22 of 26) parasitized nests were in shrubsteppe habitats. Overall, 67% of nests monitored for Brewer's, vespers, and savannah sparrows successfully fledged young. Most (89%) unsuccessful nests were lost to predation with the remainder lost to abandonment.

Logistic-exposure models indicated a significant effect of Habitat on daily survival rate of Brewer's sparrows ($\chi^2 = 6.48$, $P = 0.039$) and savannah sparrows ($\chi^2 = 10.74$, $P = 0.005$), with both species having better success in CRP compared to shrubsteppe (Fig. 6).

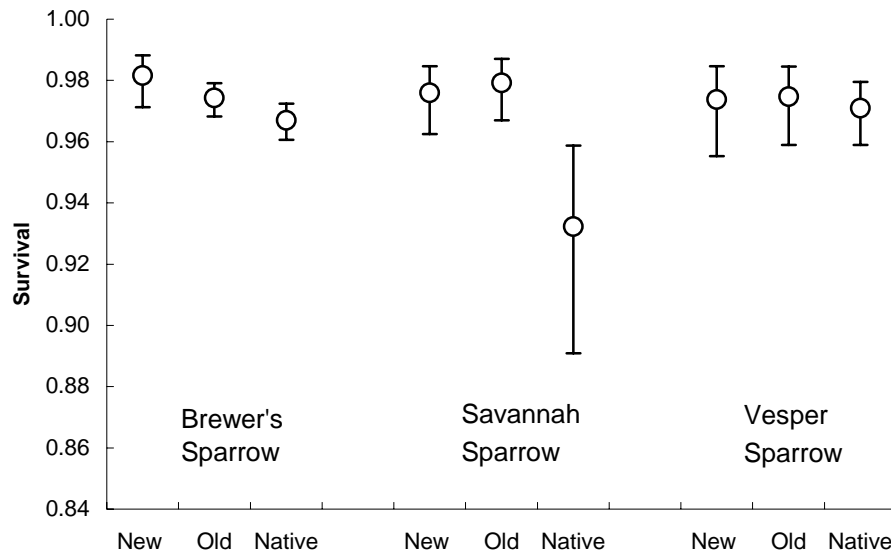

Fig. 6. Daily survival rate (mean \pm 95% CI) for nests in new CRP, old CRP, and native shrubsteppe habitats in eastern Washington.

The magnitude of this effect appears greatest in savannah sparrows where the 95% confidence interval for daily survival rate in both CRP Habitat Types did not overlap with that for native habitat (Fig. 6). Daily survival rate of nests did not differ among Habitat Types for vesper sparrows ($\chi^2 = 2.20$, $P = 0.332$). Mean clutch size and mean number of young fledged per successful nest did not differ among Habitat Types for any of the 3 species considered (Fig. 7).

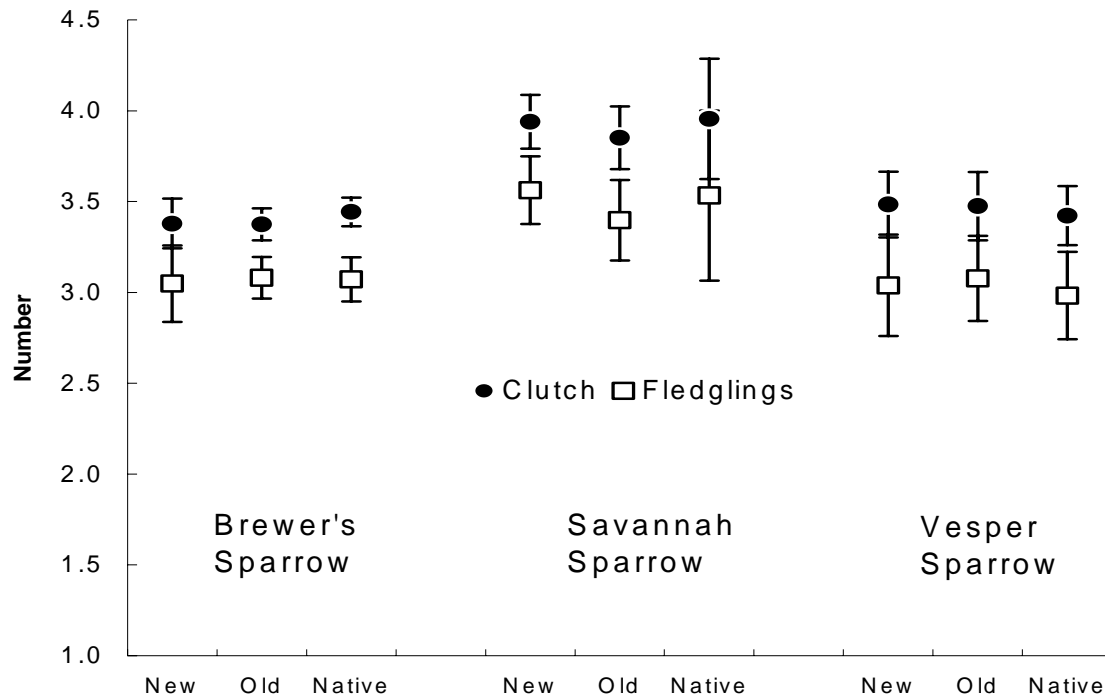

Fig. 7. Clutch size (mean \pm 95% CI) and number of fledglings from successful nests in new CRP, old CRP, and native shrubsteppe habitats in eastern Washington.

PELLET COUNTS FOR GENERAL SPECIES OF WILDLIFE

Pellets counted on the 24 study sites included 6,603 jackrabbit, 9,360 cottontail, 694 mule deer groups, 958 greater sage-grouse, 44 sharp-tailed grouse, and 222 “game bird” (gray partridge [*Perdix perdix*], chukar [*Alectoris chukar*], and ring-necked pheasant [*Phasianus colchicus*]). Deer pellet groups were found on all study areas and were more abundant in New CRP and native shrubsteppe compared to Old CRP (ANOVA, $f = 3.12$, $P = 0.049$). There was no significant difference in abundance of deer pellet groups between landscapes. Pellets of jackrabbits were found on 21 of 24 study areas examined and were more common in shrubsteppe landscapes than cropland landscapes (Friedman’s ANOVA, $f = 3.06$, $P = 0.095$) but there was no significant difference among Site Types. Logistic regression analysis also indicated a significant difference of landscape ($f = 4.1$, $P = 0.057$), with jackrabbit pellets occurring more often in shrubsteppe than in cropland landscapes. Pellets of cottontails were found on 18 of 24 study areas examined and were more abundant in native shrubsteppe habitats than in CRP habitats (Friedman’s ANOVA,

$f = 4.34, P = 0.027$); there was no significant difference between landscapes. The highest density of any pellets was observed for cottontails in an old CRP habitat in a shrubsteppe landscape (average of 50 pellets/m²).

Pellets of greater sage-grouse were found on 12 of the 24 study areas examined and 60 of 384 plots. The largest number of pellets was observed in new CRP in a shrubsteppe landscape, particularly in the Coyote Canyon area. Friedman’s ANOVA failed to find significant effects of Habitat Type or Landscape; however, examination of the raw data suggest some trends. Mean counts of pellets/hectare were greater in New CRP compared to Old CRP and also in shrubsteppe landscapes compared to cropland landscapes (Fig. 8). Old CRP in cropland landscapes showed almost no use at all. These patterns, although not testable statistically given the small sample sizes, were consistent between the 2 surveys.

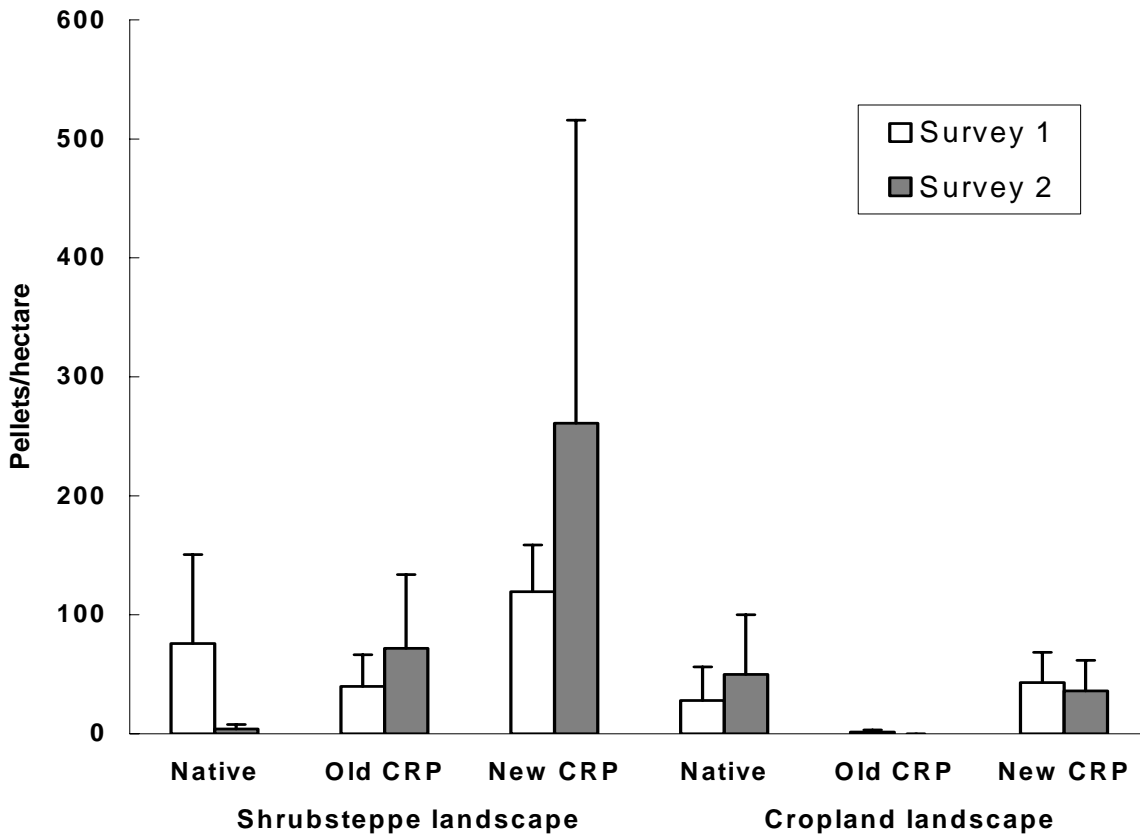

Fig. 8. Mean number of greater sage-grouse pellets counted in sites in native shrubsteppe, old CRP, and new CRP in landscapes dominated by shrubsteppe or cropland. Survey 1 took place in October 2004 and Survey 2 took place April 2005. Bars show mean and SE. One high, outlying value for survey 1 in new CRP in a shrubsteppe landscape was replaced with a value equal to the mean of the other 3 values in that class to make the figure more readable (this was done for display purposes only and did not affect the analysis).

TELEMETRY RESEARCH ON GREATER SAGE-GROUSE

A total of 204 nests were documented during the course of this study from a total of 89 females monitored between 1992 and 1998. However, because only 1 nest was found in 1998, it was eliminated from the sample. A second nest was eliminated from the analysis, because it was in a wheat field. The remaining 202 nests were either in CRP or shrubsteppe. Although shrubsteppe was considered to be a single habitat type here, it should be noted that females nesting in shrubsteppe were usually in vegetation dominated by big sagebrush, but occasionally in areas dominated by antelope bitterbrush (*Pursia tridentata*), rubber rabbitbrush (*Chrysothamnus nauseosus*), current (*Ribes* spp.), and perennial grass. CRP was also variable with some fields containing a mixture of shrubs and perennial grasses and other fields largely dominated by grasses.

Eighty-three of the 202 nests were located in CRP fields during this study; the remaining 119 nests (58.9%) were in shrubsteppe. Although neither age ($\chi^2 = 0.186$, $P = 0.667$) nor nest order ($\chi^2 = 0.990$, $P = 0.320$) were significant in the logistic regression, year offered a significant explanation ($\chi^2 = 6.600$, $P = 0.010$) for the observed variation in nest placement (Hosmer and Lemeshow test; $\chi^2 = 3.484$, $P = 0.837$) between CRP and “other” habitat. Nests were more likely to be in CRP habitats later in the study (Fig. 9), perhaps in response to the maturation of CRP fields, most of which were planted in the mid to late 1980s. Although some variability in the trend was noted, particularly in 1992 and 1997, those years also had the smallest sample sizes of nests (25 and 14 respectively). When the years are grouped into 2 categories, early years (1992-1994) and late years (1995-1997), the early years had 30.8% of nests in CRP and the late years had 49.5% of nests in CRP.

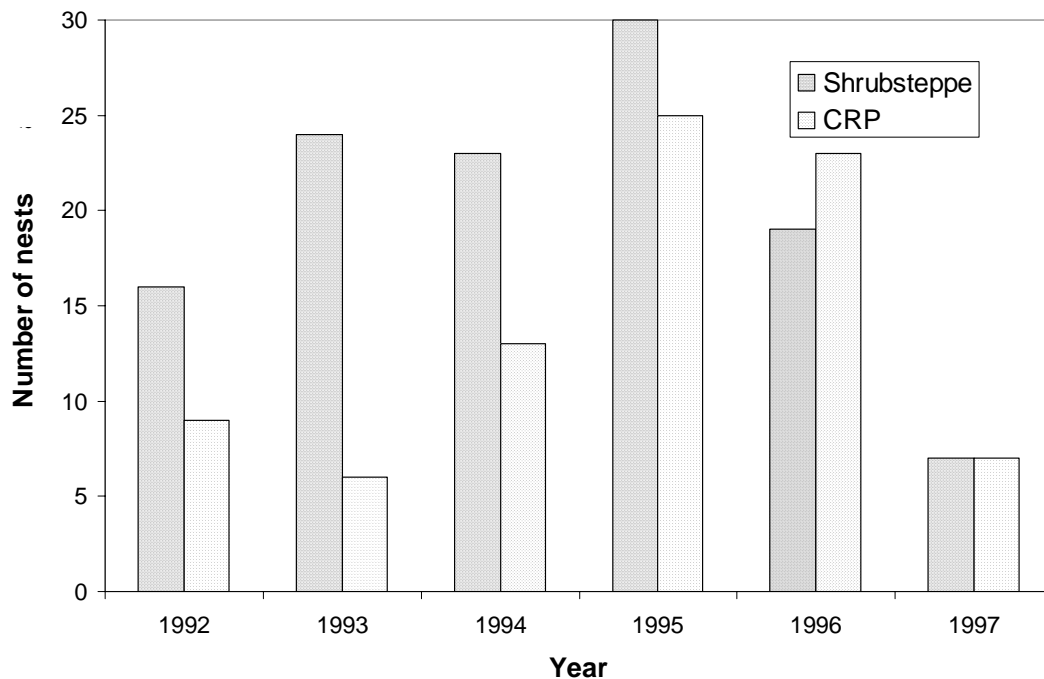

Fig. 9. Number of radio-marked greater sage-grouse nests in CRP and shrubsteppe habitats in north-central Washington between 1992 and 1997.

The shift in selection of nesting habitat was also noted when comparing individual females. Because females tend to display spatial fidelity to nesting sites (Schroeder and Robb 2003), it is likely that their consecutive nests will be in the same habitat types. Between 1992 and 1997, 121 of the 202 nests documented were additional nests for females that were already observed on a nest. Seventy-seven of those 121 nests (63.6%) were in the same habitat as the previous nest. Of the 44 changes in habitat type, 26 (59.0%) were shifts into CRP and 18 (41.0%) were shifts into shrubsteppe.

Regardless of whether nest site selection was considered for the early years, the late years, or all years combined (total of 41.1%), sage-grouse nested in CRP in proportions substantially greater than it's availability would suggest (16.7% of the sage-grouse range in north-central Washington was in CRP). Likewise, sage-grouse also nested in shrubsteppe greater than its availability would suggest (58.9% use vs. 44.3% availability). These observations are due to the almost complete absence of nests in cropland habitat, which is an abundant habitat type. If non-nesting habitats are removed from consideration, 27.4% of the potential nesting habitat is CRP and 72.6% is shrubsteppe. Under this scenario, CRP and shrubsteppe were used similar to their availability during 1992-1994, but CRP was used more and shrubsteppe was used less during 1995-1997.

Nest success was also examined in relation to habitat selection. Nests for females that were killed by predators while off the nest feeding were excluded from this analysis. In addition, nests for which success or failure of the nest was ambiguous also were excluded. These 2 criteria resulted in the exclusion of 10 nests, leaving a sample of 192 for analysis.

Nest success did not significantly differ by age of female ($\chi^2 = 0.151$, $P = 0.698$), nest order ($\chi^2 = 0.243$, $P = 0.622$), year ($\chi^2 = 0.243$, $P = 0.622$), or habitat ($\chi^2 = 0.772$, $P = 0.380$) (Hosmer and Lemeshow test; $\chi^2 = 9.329$, $P = 0.315$). There were 79 nests in CRP and 113 nests in shrubsteppe for which success could be determined. Overall nest success for this sample was 37.0%. Nest success was estimated to be 40.5% in CRP and 34.5% in shrubsteppe.

A total of 161 nests were used in the analysis of specific habitat characteristics. The difference in sample sizes from the previous analysis represented nests that could not be examined in a timely fashion or the actual nest bowl was not located. Specific characteristics of the habitat differed by general habitat type (Table 5). Every characteristic except visual obstruction and % cover of bare ground differed significantly between nests in shrubsteppe and CRP habitat. None of the significance values were marginal (i.e., with a probability close to 0.05); all were ≤ 0.003 , suggesting that the observations were not a result of multiple comparisons. In general, shrubsteppe sites were characterized by greater shrub height, species diversity, shrub cover, and forb cover, and lesser grass cover.

Table 5. Specific vegetation characteristics at 161 greater sage-grouse nest sites in relation to general habitat type (shrubsteppe or CRP) in north-central Washington.

Habitat characteristic	Shrubsteppe		CRP		Comparison	
	Average	95% C.I.	Average	95% C.I.	<i>t</i>	P
Visual obstruction (cm)	7.7	6.9 – 8.5	6.9	6.0 – 7.7	1.39	0.167
Shrub height (cm)	135.6	128.2 – 143.1	85.9	73.3 – 98.6	6.76	0.001
Species diversity	17.9	16.8 – 19.1	10.5	9.3 – 11.6	9.03	0.001
Shrub cover (%)	20.9	18.6 – 23.6	3.1	2.0 – 4.7	8.93	0.001
Grass cover (%)	41.9	39.3 – 44.6	57.4	53.6 – 61.5	6.65	0.001
Forb cover (%)	13.6	11.6 – 16.1	9.2	7.5 – 11.3	2.99	0.003
Bare ground (%)	21.3	18.7 – 24.2	22.6	20.2 – 25.3	0.71	0.482

Because of the large differences in specific habitat characteristics between general habitat types, specific habitat characteristics were examined in relation to nest success for each habitat type separately. In a logistic regression with habitat characteristics as independent variables, none of the habitat characteristics was apparently related to nest success in either shrubsteppe (overall $\chi^2 = 7.119$, $df = 7$, $P = 0.417$; Hosmer and Lemeshow $\chi^2 = 11.485$, $P = 0.176$) or CRP habitat (overall $\chi^2 = 3.638$, $df = 7$, $P = 0.820$; Hosmer and Lemeshow $\chi^2 = 2.670$, $P = 0.953$).

POPULATION RESEARCH ON GREATER SAGE-GROUSE

Sixty-five leks were documented in Washington between 1955 and 2006; 32 in north-central Washington, 23 in south-central Washington, and 10 in the Lincoln County population that is now extinct. All of the leks in north-central Washington and all of the leks in south-central Washington, except 1, were active at least as recently as 1970. There are currently 14 active leks in north-central Washington and 7 active leks in south-central Washington.

The average annual instantaneous rate of change for the pre-treatment period was -0.0159 ($SE = 0.0731$) in north-central Washington and -0.0117 ($SE = 0.0633$) in south-central Washington. Even though the variances in annual rates of change were large, the declines appeared comparable. The population in north-central Washington declined 24.9% and the population in south-central Washington declined 19.0% between 1970 and 1988. The average annual instantaneous rate of change for the treatment period was 0.0081 ($SE = 0.0701$) in north-central Washington and -0.0565 ($SE = 0.0641$) in south-central Washington. North-central Washington, following the implementation of CRP, was the only population that appeared to demonstrate a population increase. The population in north-central Washington increased 12.0%, while the population in south-central Washington decreased 54.7% between 1992 and 2006.

Observations before 1970 and observations in the Lincoln County population are consistent with the previous observations. The north-central Washington population had an instantaneous rate of change of -0.0647 (SE = 0.0705) between 1955 and 1970. This was a much larger decline than observed in the pre-treatment period. The Lincoln County population had an instantaneous rate of change of -0.0425 (SE = 0.0491) between 1957 and 1970 and a rate of change of -0.2027 (SE = 0.0959) between 1970 and 1986 (the last year that any males were observed on leks). Once again, the only increase observed was in north-central Washington following the implementation of CRP.

DISCUSSION

PASSERINE BIRDS

Conservation Reserve Program fields in our study area were used by a variety of passerine birds and in numbers equivalent to those using native shrubsteppe habitats. The primary difference between CRP and native shrubsteppe was the composition of these bird communities and the prevalence of grassland-associated birds in CRP. Studies of CRP in the prairie regions of North America also have found grassland birds generally dominating; frequently these were species displaced by conversion of prairie to cropland and included species of conservation concern (Johnson 2000, 2005). Two of the most abundant species in CRP habitats in Washington, savannah sparrows and grasshopper sparrows, have experienced long-term population declines (Sauer et al. 2004) and local populations should benefit from this new habitat. Grassland birds clearly are benefiting from CRP in Washington.

Shrubsteppe birds on our study areas were associated with native habitat and the shrubs that are a prominent component of this system. Sage sparrows, sage thrashers, and Brewer's sparrows generally nest in shrubs and their association with shrub cover is well documented (Rich 1980, Rotenberry and Wiens 1980, Vander Haegen et al. 2000). All 3 species also occurred in CRP, although the degree of use varied and likely was linked to development of the shrub layer and differences in area sensitivity. Brewer's sparrows occurred in most CRP fields that had a shrub component regardless of landscape context. Of these 3 species, Brewer's sparrows have the smallest body size and will nest in the smallest shrubs. Sage thrashers require larger shrubs for nesting (Rich 1980) but, like Brewer's sparrows, are tolerant of fragmented landscapes in Washington (Vander Haegen et al. 2000). Sage sparrows prefer large expanses of shrubsteppe (Knick and Rotenberry 1995, Vander Haegen et al. 2000) and were found in CRP only when it was contiguous with native habitat with a minimum of fragmentation.

New CRP fields in Washington held greater numbers of savannah sparrows, a ground nester and species generally associated with grass cover and that may have been attracted to the taller grass and lower percent shrub cover in these Habitat Types. Abundance of grasshopper sparrows was negatively associated with percent cover in perennial forbs, perhaps a response to the different structure of this herbaceous cover. Horned larks also

are ground-nesters but showed a pattern different from the other grassland birds. The association of horned larks with Old CRP and less cover in perennial grasses and perennial forbs likely is related to the use of open areas for nesting by this species (Rotenberry and Wiens 1980).

Shrubsteppe birds were associated more with Old CRP than New CRP and this likely was a result of the prevalence of mature, tall sagebrush plants in many Old CRP habitats. This also was the case with vesper sparrows, a ground-nesting species that nevertheless is known to be associated with shrub cover (Wiens and Rotenberry 1981, Vander Haegen et al. 2000). Whereas several New CRP fields in our sample had been planted to sagebrush, most of these shrubs were young and thus still short in stature and perhaps inadequate as nesting structures. Indeed, most New CRP fields in our sample had mean shrub heights well below the average height of shrubs used by nesting for Brewer's sparrows (85 cm), sage sparrows (90 cm) and sage thrashers (102 cm) in eastern Washington (WDFW unpublished data). Other New CRP fields apparently had not been seeded with sagebrush, or the seed had not germinated, and were essentially devoid of shrubs. Similar to Old CRP in cropland landscapes without a nearby source of sagebrush seed, these habitats were not attractive to shrub-nesting birds.

GREATER SAGE-GROUSE

CRP is clearly serving as viable nesting habitat for greater sage-grouse in north-central Washington. This conclusion is based on their selection of CRP in a proportion greater than its availability would suggest and their rates of nest success that are comparable to success rates in shrubsteppe and elsewhere in the range of greater sage-grouse (Crawford et al. 2001). Nesting females also appear willing to alter their selection of habitat from shrubsteppe to CRP, in contrast to their general tendencies to display site fidelity to nest sites (Schroeder and Robb 2003). The willingness of females to change habitats may explain, in part, why specific habitat characteristics were found to poorly relate to nest success. The increased use of CRP during the course of this study also suggests that it was becoming increasingly suitable as it matured. The reasons for this increased suitability may have been due to one or more reasons including: increasing size and abundance of big sagebrush; increasing cover of perennial grasses; and increasing success of sage-grouse nesting in CRP and/or their recognition of CRP as a potential nesting habitat.

Most of the data presented here indicates that CRP is providing habitat for nesting greater sage-grouse that is at least as suitable as shrubsteppe habitat. It should be noted that all shrubsteppe habitat is not equal. Some shrubsteppe is characterized by abundant perennial grasses while other shrubsteppe is characterized by the almost complete absence of perennial grasses. Observations of nest-site selection within shrubsteppe have suggested that the abundance of perennial grasses may be an important consideration and a likely explanation for the avoidance of some shrubsteppe as potential nesting habitat. There is also variation within CRP habitats. In Washington, it was clear that sage-grouse selected CRP that had relatively thick cover of perennial grasses and/or shrubs for nest sites. These sites also tended to be in landscapes dominated by shrubsteppe.

CRP was frequently used by radio-marked sage-grouse during other times of year, but especially by brood-rearing females. Although birds were also observed in CRP during autumn, winter, and spring, birds were more likely to be in the continuous areas of shrubsteppe that supplied sagebrush as an abundant source of food (Schroeder et al. 1999). Use of shrubsteppe during winter was particularly important during periods of consistent and relatively deep snow cover, probably linked to a need for access to sagebrush for food. Although sage-grouse were not observed using CRP regularly in winter during the course of the radio-telemetry portion of this study (1992-1997), they were observed using CRP in winter between 2003 and 2005. The reason for this difference was apparently an alteration in the type of CRP that was available. CRP available in 2003-2005 was planted (in late 1990s) with big sagebrush, thus providing a food source for wintering sage-grouse. Although CRP available during 1992-1997 also had some sagebrush, it tended to be relatively sparse and less likely to provide suitable cover and food.

CRP appears to be gaining in importance as nesting, brood-rearing, and wintering habitat for sage-grouse in Washington but likely is not important as lek habitat. In general, lek sites tend to be characterized by relatively open vegetation; there is little evidence that lek habitat is limiting (Schroeder et al. 1999, Connelly et al. 2000). Between 1992 and 2005 there has been an average of 13 leks per year in north-central Washington. Although the leks tend to be in approximately the same location each year, there is some localized shifting of locations in response to habitat change. For example, during the 1992-1997 portion of this study, 3 of the leks were in shrubsteppe, 9 leks were in wheat fields, and 1 lek was in CRP. Between 1997 and 2003, three of the wheat fields with leks were converted to CRP. In all three cases the lek shift to an adjacent field that was still in wheat. Likewise, the lek that was in CRP during the 1992-1997 period also shifted to an adjacent wheat field as the vegetation in the field began to get thicker. However, because fields with short vegetation (i.e., wheat fields) are distributed throughout Douglas County, there is no evidence that lek habitat is limiting.

CRP and shrubsteppe are not independent habitats in north-central Washington. Because of the historical mix of cropland and shrubsteppe in the region, there is a close special association between the 2 habitat types. It was not unusual for sage-grouse to nest on the edge of habitats, therefore having easy access to multiple habitats with short movements. It seemed clear during the course of this study that the presence of CRP next to shrubsteppe improved the usefulness of the shrubsteppe for sage-grouse. Likewise, the presence of shrubsteppe next to CRP improved the quality of the CRP. The vast majority of sites used by sage-grouse in Washington would have been classified as being in a shrubsteppe-dominated landscape.

Nesting and early brood-rearing have clearly been identified as the most important time periods in the annual life cycle of sage-grouse (Connelly et al. 2004). Because CRP is clearly supporting a substantial portion of the sage-grouse breeding population in north-central Washington, it is likely that the population would be severely impacted if the CRP program ended. Although sage-grouse females would likely nest in shrubsteppe if CRP were not present, territoriality among females would preclude many females from having the opportunity to select the best shrubsteppe habitats. Although data within shrubsteppe

habitat was not presented here, it was clear that there is tremendous variability in the habitat characteristics within shrubsteppe, and that these characteristics have a dramatic affect on nest-site selection. In any case it is clear that the loss of CRP would likely push the north-central Washington population of greater sage-grouse closer to extirpation.

It is difficult to make a statistical assessment of the possible differences in annual rates of population change. This is partly due to the tremendous amount of annual variation in population size, as well as to the potential biases associated with lek count techniques (Connelly et al. 2004). Connelly et al. (2004) used Monte Carlo simulations to evaluate the typical sampling procedure of sage-grouse populations. Their simulations, which were based on sampling procedures more variable than in Washington, suggested that the annual rates of change observed in Washington were at least 60% likely to represent actual population changes, and in one case at least 90% likely to represent an actual population change (i.e., the change of -0.0565 in south-central Washington). When the likely decrease in south-central Washington is considered in conjunction with the possible increase in north-central Washington, it is clear that the 2 populations are moving in different directions. The observations of sage-grouse use of CRP are consistent with these divergent annual rates of population change. North-central Washington, following the implementation of CRP, was the only population that demonstrated a population increase. This is particularly noteworthy given the widespread declines of most populations of sage-grouse in North America during the same time interval (Connelly et al. 2004).

MANAGEMENT IMPLICATIONS

Shrubsteppe passerines are benefiting from CRP both through creation of suitable nesting habitat and development of a more contiguous “non-cropland” landscape where CRP adjoins fragments of native shrubsteppe. Brewer’s sparrows and sage thrashers used CRP regardless of landscape as long as suitable shrubs were present; however, pairs that nested in shrubsteppe landscapes likely maximized benefits to local and regional populations. Previous work in Washington has demonstrated lower nesting success for sage thrashers and Brewers’ sparrows and lower seasonal reproductive success for Brewer’s sparrows and sage sparrows, in landscapes fragmented by agriculture (Vander Haegen et al. 2002, Vander Haegen 2007). Although we did not measure nesting success of birds using CRP in cropland landscapes, it likely was lower than that documented for birds using CRP in native landscapes. If CRP can contribute to creating contiguous “non-cropland” landscape it will benefit area-sensitive species like sage sparrows by providing more habitat—both CRP fields and fragments of native shrubsteppe that fit the species’ search image. Moreover, these expanded landscapes may provide areas of greater reproductive success for species that are adversely affected by fragmentation.

We were limited in our assessment of New CRP in that sagebrush had been planted in these habitats only since 1996. As the vegetation on these areas matures and shrub height increases they likely will see increasing use by shrubsteppe passerines and by sage-grouse. Old CRP fields with well-established sagebrush cover had abundances of Brewer’s sparrows and sage thrashers that equaled or were close to that observed in

native shrubsteppe. It is likely that New CRP will support equivalent numbers of birds given an equal cover of mature sagebrush

When the observations of greater sage-grouse and CRP are considered in total, the following points can be made. First, CRP was of the greatest benefit to sage-grouse when it contained sagebrush and when it was in a shrubsteppe landscape. These observations are based on the distribution and abundance of pellets, as well as on documented changes in the distribution of sage-grouse (Schroeder et al. 2000). Second, CRP with a sagebrush component is increasingly providing suitable nesting habitat for sage-grouse. This observation is based on the frequent use of CRP by nesting sage-grouse, the relative success of nesting sage-grouse in CRP, as well as on the increase of CRP use between 1992 and 1997. Third, the use of CRP by sage-grouse in north-central Washington appears to be correlated with slight increases in population size. This observation is particularly noteworthy given the clear decline of sage-grouse in south-central Washington during the same time interval and the decline of sage-grouse in both south-central and north-central Washington during the pre-treatment interval.

FUTURE RESEARCH

Our research on shrubsteppe and grassland passerines in north-central Washington was restricted to a relatively small geographic area in relation to the distribution of these species and the distribution of CRP. The expanded surveys that we completed in 2006 will help us to assess how the patterns that we observed may apply over a larger region and these results will be the subject of a future report. It would be valuable to collect similar data from other states and other regions to test if the patterns that we observed in Washington also occur in areas with different landscapes, suites of species, and populations of nest predators.

Although CRP is clearly benefiting sage-grouse in north-central Washington, it is possible that these observations are peculiar to the habitat arrangement in this area and that the same observations may not be applicable to other areas. For example, Douglas County has a relatively large component of cropland (Table 1), and consequently, the quantity of potential nesting habitat may have been limiting prior to implementation of the CRP. In regions with a smaller proportion of cropland, it is possible that replacement of the cropland with CRP would make little difference. It is also possible that sage-grouse in north-central Washington are adapted to a slightly different habitat than sage-grouse elsewhere (e.g., more grass). For example, in an assessment of sage-grouse productivity, Schroeder (1997) found that sage-grouse in north-central Washington displayed some unusual tendencies when compared with sage-grouse elsewhere such as larger clutch sizes and higher rates of nest initiation and renesting. It is also possible that these unusual tendencies are related to the unique configuration of cropland (and hence CRP) with shrubsteppe in north-central Washington (Schroeder et al. 2000).

The best way to examine the utility of these observations to other areas would be to examine long-term population data for different locations throughout the range of sage-grouse (data used in Connelly et al. 2004). These data could be compared for multiple

areas using controls with both pre-treatment and treatment data, as was done here for Washington. Areas of particular interest include portions of the current distribution of greater sage-grouse that also include abundant CRP such as northern Utah, southeastern Idaho, western Colorado, and eastern Montana.

LITERATURE CITED

- Aldrich, J. W. 1963. Geographic orientation of American Tetraonidae. *Journal of Wildlife Management* 27:529-545.
- Allison, P. D. 1999. *Logistic Regression Using the SAS System: Theory and Application*. SAS Institute, Gary, North Carolina.
- Amstrup, S. C. 1980. A radio-collar for game birds. *Journal of Wildlife Management* 44:214-217.
- Beck, T. D. I., R. B. Gill, and C. E. Braun. 1975. Sex and age determination of Sage Grouse from wing characteristics. Colorado Department of Natural Resources Game Information Leaflet 49 (Revised), Denver, USA.
- Braun, C. E. 1998. Sage grouse declines in western North America: what are the problems? *Proceedings of the Western Association of State Fish and Wildlife Agencies* 78:139-156.
- Buss, I. O., and E. S. Dziedzic. 1955. Relation of cultivation to the disappearance of the Columbian sharp-tailed grouse from southeastern Washington. *Condor* 57:185-187.
- Connelly, J. W., and C. E. Braun. 1997. Long-term changes in sage grouse *Centrocercus urophasianus* populations in western North America. *Wildlife Biology* 3:229-234.
- Connelly, J. W., W. L. Wakkinen, A. P. Apa, and K. P. Reese. 1991. Sage grouse use of nest sites in southeastern Idaho. *Journal of Wildlife Management* 55:521-524.
- Connelly, J. W., M. A. Schroeder, A. R. Sands, and C. E. Braun. 2000. Guidelines to manage sage grouse populations and their habitats. *Wildlife Society Bulletin* 28:967-985.
- Connelly, J. W., S. T. Knick, M. A. Schroeder, and S. J. Stiver. 2004. Conservation assessment of greater sage-grouse and sagebrush habitats. *Western Association of Fish and Wildlife Agencies Report*. Cheyenne, Wyoming.

- Crawford, J. A., R. A. Olson, N. E. West, J. C. Mosley, M. A. Schroeder, T. D. Whitson, R. F. Miller, M. A. Gregg, and C. S. Boyd. 2004. Ecology and management of sage-grouse and sage-grouse habitats. *Journal of Range Management* 57:2-19.
- Daubenmire R. 1970. *Steppe vegetation of Washington*. Pullman, WA: Washington State University. Cooperative Extension Bulletin EB 1446.
- Dobler, F. C., J. Eby, C. Perry, S. Richardson, and M. Vander Haegen. 1996. Status of Washington's shrub-steppe ecosystem: Extent, ownership, and wildlife/vegetation relationships. Research Report. Washington Department of Fish and Wildlife, Olympia.
- Eggebo, S.L. 2001. Ring-necked pheasant and passerine abundance in Conservation Reserve Program grasslands of differing age-classes and cover types in eastern South Dakota, 1998-2000. M.S. Thesis, South Dakota State University, Brookings.
- Emmons, S. R., and C. E. Braun. 1984. Lek attendance of male Sage Grouse. *Journal of Wildlife Management* 48:1023-1028.
- Gregg, M. A., J. A. Crawford, M. S. Drut, and A. K. DeLong. 1994. Vegetative cover and predation of sage grouse nests in Oregon. *Journal of Wildlife Management* 58:162-166.
- Hays, D. W., M. J. Tirhi, and D. W. Stinson. 1998. Washington State status report for the sage grouse. Washington Department of Fish and Wildlife, Olympia, Washington.
- Hosmer, D. W., and S. Lemeshow. 2000. *Applied logistic regression*. Second Edition. Wiley, New York.
- Howerton, Jack. 1986. Wildlife protection, mitigation, and enhancement planning for Grand Coulee Dam. WDFW. Olympia, Washington.
- Jacobson, J. E., and M. C. Snyder. 2000. Shrubsteppe mapping of eastern Washington using Landsat Satellite Thematic Mapper data. Washington Department of Fish and Wildlife, Olympia, Washington.
- Jenni, D. A., and J. E. Hartzler. 1978. Attendance at a sage grouse lek: implications for spring censuses. *Journal of Wildlife Management* 42:46-52.
- Johnson, D. H. 2000. Grassland bird use of Conservation Reserve Program fields in the Great Plains. Pages 19-34 in W. L. Hohman and D. J. Halloum, editors. A comprehensive review of Farm Bill contributions to wildlife conservation, 1985-2000. U.S. Department of Agriculture, Natural Resources Conservation Service, Wildlife Habitat Management Institute, Technical Report USDA/NRCS/WHMI-2000.

- Johnson, D. H. 2005. Grassland bird use of Conservation Reserve Program fields in the Great Plains. Pages 17-32 in J. B. Haufler, editor. Fish and wildlife benefits of Farm Bill Conservation Programs: 2000-2005 update. The Wildlife Society Technical Review 05-2.
- Jones, S. L., and J. E. Cornely. 2002. Vesper sparrow (*Pooecetes gramineus*). In A. Poole and F. Gill (Eds.), The birds of North America, No. 624. The Birds of North America, Inc., Philadelphia, Pennsylvania.
- Knick, S. T., and J. T. Rotenberry. 1995. Landscape characteristics of fragmented shrubsteppe habitats and breeding passerine birds. *Conservation Biology* 9:1059-1071.
- Knick, S. T., D. S. Dobkin, J. T. Rotenberry, M. A. Schroeder, W. M. Vander Haegen, and C. Van Ripper, III. 2003. Teetering on the edge or too lake? Conservation and research issues for avifauna of sagebrush habitats. *Condor* 105:611-634.
- Pashley, D. N., C. J. Beardmore, J. A. Fitzgerald, R. P. Ford, W. C. Hunter, M. S. Morrison, and K. V. Rosenberg. 2000. Partners in Flight: conservation of the land birds of the United States. American Bird Conservancy.
- Patterson, M. P., and L. B. Best. 1996. Bird abundance and nest success in Iowa CRP fields: the importance of vegetation structure and composition. *American Midland Naturalist* 135:153-167.
- Quigley, T. M., and S. J. Arbelbide. 1997. An assessment of ecosystem components in the interior Columbia basin and portions of the Klamath and Great Basins. USDA Forest Service Pacific Northwest Research Station General Technical Report PNW-GTR-405. Portland, Oregon.
- Ralph, C. J., G. R. Geupel, P. Pyle, T. E. Martin, and D. F. DeSante. 1993. Handbook of field methods for monitoring landbirds. USDA Forest Service Pacific Southwest Research Station General Technical Report PSW-GTR-144. Albany, California.
- Rich, T. 1980. Nest placement in sage thrashers, sage sparrows and Brewer's sparrows. *Wilson Bulletin* 92:362-368.
- Robel, R. J., J. N. Briggs, A. D. Dayton, and L. C. Hulbert. 1970. Relationship between visual obstruction measurements and weight of grassland vegetation. *Journal of Range Management*. 23:295-297.
- Rotenberry, J. T., and J. A. Wiens. 1980. Habitat structure, patchiness, and avian communities in North American steppe vegetation: a multivariate analysis. *Ecology* 61:1228-1250.

- Saab, V. A., and T. D. Rich. 1997. Large-scale conservation assessment for Neotropical migratory land birds in the interior Columbia River Basin. USDA Forest Service Pacific Northwest Research Station General Technical Report PNW-GTR-399. Portland, Oregon.
- SAS Institute. 2006. SAS Institute. 2006. SAS version 9.1. SAS Institute, Cary, North Carolina.
- Sauer, J. R., J. E. Hines, and J. Fallon. 2004. The North American Breeding Bird Survey, Results and Analysis 1966 - 2003. Version 2004.1. USGS Patuxent Wildlife Research Center, Laurel, Maryland.
- Schroeder, M. A. 1997. Unusually high reproductive effort by sage grouse in a fragmented habitat in north-central Washington. *Condor* 99:933-941.
- Schroeder, M. A., and C. E. Braun. 1991. Walk-in traps for capturing Greater Prairie-chickens on leks. *Journal of Field Ornithology* 62:378-385.
- Schroeder, M. A., and L. A. Robb. 2003. Fidelity of sage-grouse *Centrocercus urophasianus* to breeding areas in a fragmented landscape. *Wildlife Biology* 9:291-299.
- Schroeder, M.A., J.R. Young, and C.E. Braun. 1999. Sage grouse (*Centrocercus urophasianus*). In *The birds of North America*. No. 425 (A. Poole and F. Gill, eds.). The Birds of North America, Inc., Philadelphia, PA.
- Schroeder, M. A., D. W. Hays, M. F. Livingston, L. E. Stream, J. E. Jacobson, and D. J. Pierce. 2000. Changes in the distribution and abundance of sage grouse in Washington. *Northwestern Naturalist* 81:104-112.
- Schroeder, M. A., C. L. Aldridge, A. D. Apa, J. R. Bohne, C. E. Braun, S. D. Bunnell, J. W. Connelly, P. A. Deibert, S. C. Gardner, M. A. Hilliard, G. D. Kobriger, S. M. McAdam, C. W. McCarthy, J. J. McCarthy, D. L. Mitchell, E. V. Rickerson, and S. J. Stiver. 2004. Distribution of sage-grouse in North America. *The Condor* 106:363-376.
- Shaffer, T. L. 2004. A unified approach to analyzing nest success. *Auk* 121:526-540.
- Swenson, J. E., C. A. Simmons, and C.D. Eustace. 1987. Decrease of sage grouse after plowing of sagebrush steppe. *Biological Conservation* 41: 125-132.
- Vander Haegen, W. M. 2007. Fragmentation by agriculture influences reproductive success of birds in a shrubsteppe landscape. *Ecological Applications* (*in press*).
- Vander Haegen, W. M., and B. Walker. 1999. Parasitism by brown-headed cowbirds in the shrubsteppe of eastern Washington. *Studies in Avian Biology* 18:34-40.

- Vander Haegen, W. M., F. C. Dobler, and D. J. Pierce. 2000. Shrubsteppe bird response to habitat and landscape variables in eastern Washington, USA. *Conservation Biology* 14:1145–1160.
- Vander Haegen, W. M., S. M. McCorquodale, C. R. Peterson, G. A. Green, and E. Yensen. 2001. Wildlife of eastside shrubland and grassland habitats. Pages 474-500 in D. H. Johnson and T. A. O’Neil, editors. *Wildlife-habitat relationships in Oregon and Washington*. Oregon State University Press, Corvallis, Oregon.
- Vander Haegen, W. M., M. A. Schroeder, and R. M. DeGraaf. 2002. Predation on real and artificial nests in shrubsteppe landscapes fragmented by agriculture. *Condor* 104:496-506.
- Walsh, D. P. 2002. Population estimation techniques for greater sage-grouse. Thesis, Colorado State University, Fort Collins.
- Walsh, D. P., G. C. White, T. E. Remington, and D. C. Bowden. 2004. Evaluation of the lek-count index for greater sage-grouse. *Wildlife Society Bulletin* 32:56-68.
- Washington Department of Fish and Wildlife. 1995. Washington State management plan for sage grouse. Game Division, Washington Department of Fish and Wildlife, Olympia, Washington.
- Wiens, J. A., and J. T. Rotenberry. 1981. Habitat associations and community structure of birds in shrubsteppe environments. *Ecological Monographs* 51:21-41.
- Wisdom, M. J., R. S. Holthausen, B. C. Wales, C. D. Hargis, V. A. Saab, D. C. Lee, W. J. Hann, T. D. Rich, M. M. Rowland, W. J. Murphy, and M. R. Eames. 2000. Source habitats for terrestrial vertebrates of focus in the interior Columbia Basin: broad-scale trends and management implications. USDA Forest Service General Technical Report PNW-GTR-485.
- Yensen, E., D. Quinney, K. Johnson, K. Timmerman, and K. Steenhof. 1992. Fire, vegetation changes, and population fluctuations of Townsend’s ground squirrels. *American Midland Naturalist* 128:299-312.
- Yocom, C. F. 1956. The sage hen in Washington State. *Auk* 73:540-550.